

**Amend PFM 6-0000 (STORM DRAINAGE – TABLE OF CONTENTS) to read as follows:**

<b>6-0000</b>	<b>STORM DRAINAGE – TABLE OF CONTENTS</b>	6-0802	SCS Hydrology
		6-0803	Rational Formula
		6-0804	Anderson Formula
		6-0805	Other Hydrologies
<b>6-0100</b>	<b>GENERAL INFORMATION</b>	6-0806	Incremental Unit Hydrograph – 1 Impervious Acre
6-0101	Drainage Systems		
6-0102	VDOT Requirements		
6-0103	Metric Requirements		
<b>6-0200</b>	<b>POLICY AND REQUIREMENTS FOR ADEQUATE DRAINAGE</b>	<b>6-0900</b>	<b>CLOSED CONDUIT SYSTEM</b>
6-0201	Policy of Adequate Drainage	6-0901	Design Flow
6-0202	Minimum Requirements	6-0902	Storm Sewer Pipe
6-0203	Analysis of Downstream Drainage System	6-0903	Pipe and Culvert Materials
6-0204	Submission of Narrative Description and Downstream Analysis	6-0904	Energy and Hydraulic Gradients
6-0205	Small Private Drainage System	6-0905	Closed Conduit Design Calculations
		6-0906	Minimum Radius of Curvature for Concrete Pipeline
<b>6-0300</b>	<b>POLICY ON DETENTION OF STORMWATERS</b>	<b>6-1000</b>	<b>OPEN CHANNELS</b>
6-0301	General Policy	6-1001	Water Surface Profiles (Standard Step Method and Direct Step Method)
6-0302	Detention Measures	6-1002	Side Ditches and Median Ditches
6-0303	Location of Detention Facilities	6-1003	Channel Charts
		6-1004	Design Criteria
<b>6-0400</b>	<b>STORMWATER RUNOFF QUALITY CONTROL CRITERIA</b>	6-1005	Channel Size and Shape
6-0401	General Information and Regulations	6-1006	Channel Materials
6-0402	Stormwater Quality Control Practices	6-1007	Energy and Hydraulic Gradients
		6-1008	Channel Design Calculations
<b>6-0500</b>	<b>POLICY ON OFF-SITE DRAINAGE IMPROVEMENTS</b>	6-1009	Sample – Paved Ditch Computations
6-0501	Purpose and Intent	6-1010	Sample – Paved Ditch Computations
6-0502	General Policy	6-1011	Sample – Paved Ditch Computations
		6-1012	Paved Ditch Construction Specifications
<b>6-0600</b>	<b>POLICY ON PROPORTIONATE COST OF OFF-SITE DRAINAGE IMPROVEMENTS</b>	<b>6-1100</b>	<b>STORM SEWER APPURTENANCES</b>
6-0601	General Requirements	6-1101	General
6-0602	Pro Rata Share Studies	6-1102	Curb Inlets
6-0603	General Drainage Improvement Program	6-1103	Yard Inlets
6-0604	Pro Rata Share Payments	6-1104	Frames & Covers
		6-1105	Grate Inlets
<b>6-0700</b>	<b>POLICY ON WHAT MAY BE DONE IN FLOODPLAINS</b>	6-1106	Open Top Structures
6-0701	Applicability	6-1107	Energy Dissipation Devices
6-0702	Alteration of Floodplains	6-1108	Drainage in Residential Areas
6-0703	Use Regulations in Floodplain Areas	6-1109	Inlet Design Calculations
6-0704	Floodplain Development Standards	6-1110	Storm Sewer Construction Specifications
6-0705	Warning and Disclaimer of Liability		
<b>6-0800</b>	<b>HYDROLOGIC DESIGN</b>	<b>6-1200</b>	<b>CULVERTS</b>
6-0801	Acceptable Hydrologies	6-1201	Design Flow
		6-1202	Size
		6-1203	Culvert Materials
		<b>6-1300</b>	<b>RETENTION, AND DETENTION, AND LOW IMPACT DEVELOPMENT FACILITIES</b>
		6-1301	General Requirements

6-1302	Rooftop Storage	<b>6-1600</b>	<b>DESIGN AND CONSTRUCTION OF DAMS AND IMPOUNDMENTS</b>
6-1303	Percolation Trenches	6-1601	Virginia Dam Safety Regulations
6-1304	<del>Porous Asphalt</del> <u>Pervious Pavement</u>	6-1602	County Dam Safety Regulations
6-1305	Retention and Detention Ponds	6-1603	Hydrologic Design Criteria for Dams Regulated by the County
6-1306	Maintenance Design Considerations	6-1604	Design Guidelines for Spillways
6-1307	<u>Bioretention Filters and Basins</u>	6-1605	Geotechnical Design Guidelines for Stormwater Management Reservoirs with Earthdams
6-1308	<u>Vegetated Swales</u>	6-1606	Maintenance and Safety Design Requirements
6-1309	<u>Tree Box Filters</u>	6-1607	Minimum Required Construction Standards, Specifications and Inspection Requirements
6-1310	<u>Vegetated Roofs</u>	6-1608	Operation, Maintenance, and Inspection Guidelines
6-1311	<u>Reforestation</u>		
<b>6-1400</b>	<b>FLOODPLAIN</b>		
6-1401	Requirements		
6-1402	Flows		
6-1403	Methods and Guidelines for Calculations		
6-1404	Water Surface Calculations		
6-1405	Floodplain Easement		
<b>6-1500</b>	<b>ON-SITE MAJOR STORM DRAINAGE SYSTEM</b>	<b>6-1700</b>	<b>POLICY ON WHAT MAY BE DONE IN CHESAPEAKE BAY PRESERVATION AREAS</b>
6-1501	Guidelines for Major Drainage System	6-1701	General Information
6-1502	Major Drainage System Design Calculation	6-1702	Use Regulations in Chesapeake Bay Preservation Areas
6-1503	Overlot Grading in Residential Areas	6-1703	Water Quality Impact Assessments

**6-1800 PLATES**

<b>STANDARD DESIGNATION</b>	<b>PLATE NO.</b>	<b>DESCRIPTION</b>	<b>SECTION</b>
N/A	1-6 (1M-6)	Small Private Drainage System	6-0204
N/A	2-6 (2M-6)	Water Quality Storage Requirements Related to Percent Imperviousness and Rational Formula "C" Factor	6-0402
N/A	3-6 (3M-6)	Intensity Duration Frequency Curves	6-0803
N/A	4-6 (4M-6)	Time of Concentration of Small Drainage Basins	6-0803
N/A	5-6 (5M-6)	Velocity and Flow Time in Gutter	6-0803
N/A	6-6 (6M-6)	Flood Frequency Curves for Selected Degrees of Basin Imperviousness	6-0804
N/A	7-6 (7M-6)	Lag Time as a Function of Length-Slope Index	6-0804
N/A	8-6 (8M-6)	Nomograph for Computing Required Size of Circular Drain, Flowing Full	6-0902
CTY-1	9-6 (9M-6)	Standard Reinforced Concrete Prefabricated "T" or "Y" Connection	6-0902
CB-1	10-6 (10M-6)	Standard Reinforced Concrete Prefabricated Bend	6-0902
DPW-26	11-6 (11M-6)	Concrete Pier for Storm Sewer Pipe	6-0902
N/A	12-6 (12M-6)	Closed Conduit	6-0904
N/A	13-6 (13M-6)	Energy Losses at Storm Sewer Junctions	6-0904
N/A	14-6 (14M-6)	Energy Losses at Storm Sewer Junctions	6-0904
N/A	15-6 (15M-6)	Closed Conduit Junction	6-0904
RC-1	16-6 (16M-6)	Minimum Radius of Curvature for Concrete Pipeline	6-0906

<b>STANDARD DESIGNATION</b>	<b>PLATE NO.</b>	<b>DESCRIPTION</b>	<b>SECTION</b>
RC-2	17-6 (17M-6)	Minimum Radius of Curvature for Concrete Pipeline – Beveled Pipe	6-0906
RC-2A	18-6 (18M-6)	Minimum Radius of Curvature for Concrete Pipeline – Beveled Pipe	6-0906
PD-A, B, C, D	19-6 (19M-6)	Paved Ditches Type A, B, C, and D	6-1002
TR-1	20-6 (20M-6)	Transition – Paved or Sodded Ditch to Yard Inlet	6-1002
GB-1	21-6 (21M-6)	Gabions – Typical Section Open Channel	6-1002
GB-2	22-6 (22M-6)	Gabions – Typical Section Revetment with Toe Wall	6-1002
GB-3	23-6 (23M-6)	Gabions – Typical Section Weir	6-1002
N/A	24-6 (24M-6)	Open Channel	6-1007
N/A	25-6 (25M-6)	Energy Loss Coefficients for Curved Channels	6-1007
N/A	26-6 (26M-6)	Open Channel Transition and/or Horizontal Curve	6-1007
N/A	27-6 (27M-6)	Manning n for Vegetal-Lined Channels (Deleted by 61-98-PFM)	
N/A	28-6 (28M-6)	Curb Inlet Design Chart – Curb Inlets on Grade	6-1102
N/A	29-6 (29M-6)	Curb Inlet Design Chart – Curb Inlets on Grade	6-1102
N/A	30-6 (30M-6)	Spread and Depth of Gutter Flow vs. Cross Slope	6-1102
N/A	31-6 (31M-6)	Capacity of Curb Inlets and Yard Inlets at Low Point in Grade	6-1102
YI-1	32-6 (32M-6)	Standard Yard Inlet	6-1103
YI-1	33-6 (33M-6)	Typical Concrete Apron for Yard Inlets	6-1103
MH-1	34-6 (34M-6)	Standard Manhole Cover and Frame for Use in Easements Outside of VDOT Right-of-Way	6-1104
N/A	35-6 (35M-6)	Hydraulic Capacity of Grate Inlets on Grades	6-1105
N/A	36-6 (36M-6)	Hydraulic Capacity of Grate Inlet in Sump	6-1105
N/A	37-6 (37M-6)	Rooftop Stormwater Detention	6-1302
N/A	38-6 (38M-6)	Typical Rainfall Ponding Ring Sections	6-1302
N/A	39-6 (39M-6)	Mass Diagram	6-1303.6A(3)
N/A	40-6 (40M-6)	Unit Inflow Hydrograph – 10-Year – 2-Hour Storm – 1 Impervious Acre	6-1303.7B
N/A	41-6 (41M-6)	Unit Hydrograph per Impervious Acre 100-Year Frequency Storm	6-1303.7B
N/A	41A-6 (41AM-6)	Percolation Trench	6-1303.4B
SW-1	41B-6 (41BM-6)	Notice of Location of Stormwater Facility	6-1305.7F
N/A	42-6 (42M-6)	Unit Flow Hydrograph – 2-Year – 2-Hour Storm	6-1305
N/A	43-6 (43M-6)	Discharge – 15" (375mm) Culvert	6-1305
N/A	44-6 (44M-6)	Inflow Hydrograph – 10-Year – 2-Hour Storm – 5-Minute Time of Concentration	6-1305
N/A	45-6 (45M-6)	Floodplain	6-1403
N/A	46-6 (46M-6)	24-Hour Design Storm Chart for Spillway Design Flood (SDF)	6-1603
N/A	47-6 (47M-6)	County 100-Year, 24-Hour Rainfall Distribution	6-1603
N/A	48-6 (48M-6)	100-Year, 24-Hour Rainfall Distribution (Hyetograph)	6-1603
N/A	49-6 (49M-6)	Typical Wet (Retention) Pond Layout Showing Key Elements	6-1604
N/A	50-6 (50M-6)	Typical Dry or Extended Dry (Detention) Pond Layout Key Elements	6-1604
N/A	51-6 (51M-6)	Typical Sections at Stormwater Management Facilities	6-1604
N/A	52-6 (52M-6)	Permissible Velocities for Vegetated Emergency Spillways	6-1604

<b>STANDARD DESIGNATION</b>	<b>PLATE NO.</b>	<b>DESCRIPTION</b>	<b>SECTION</b>
N/A	53-6 (53M-6)	Schematic Detail of Pre-Cast Circular Riser and Trash Rack for Use with Dry or Extended Dry Detention Ponds	6-1604
N/A	54-6 (54M-6)	Schematic Detail of Standard Cast in Place Rectangular Riser and Trash Rack for Use with Wet or Dry Ponds	6-1604
N/A	55-6 (55M-6)	SCS Standard 2-Way Covered Riser for Use with Wet or Dry Ponds	6-1604
N/A	56-6 (56M-6)	Typical Wet (Retention) Pond Layout when Using Roadway Embankments as Dams	6-1604
N/A	57-6 (57M-6)	Typical Dry or Extended Dry (Detention) Pond Layout when Using Roadway Embankments as Dams	6-1604
N/A	58-6 (58M-6)	Riprap Size for Use Downstream of Energy Dissipators	6-1604
N/A	59-6 (59M-6)	Riprap Placement for Outlet Protection Below Culverts	6-1604
N/A	60-6 (60M-6)	Riprap Basin	6-1604
N/A	61-6 (61M-6)	BMP Extended Drawdown Device (Example Detail)	6-1604
N/A	62-6 (62M-6)	Example Low Level Drain for a Wet Pond –Sluice Gate Nomenclature	6-1604
N/A	63-6 (63M-6)	Trickle Ditch Detail	6-1604
N/A	64-6 (64M-6)	Minimum Geotechnical Design Standards for Small Dams	6-1605
N/A	65-6 (65M-6)	Typical Embankment Dam Sections (See continuation on Plate 66-6 (66M-6))	6-1605
N/A	66-6 (66M-6)	Typical Embankment Dam Sections (Continued from Plate 65-6 (65M-6))	6-1605
N/A	67-6 (67M-6)	Standard Concrete Cradle Details for Circular Conduits Extending Through Dam Embankments	6-1605
N/A	68-6 (68M-6)	Suggested Minimum & Maximum Core Sizes for Small Dams with Zoned Embankments	6-1605
N/A	69-6 (69M-6)	Recommended Side Slopes for Small Dams on Stable Foundations	6-1605
N/A	70-6 (70M-6)	Standard Maintenance Access Road Details for Stormwater Management Ponds	6-1606
N/A	71-6 (71M-6)	Standard Access Road Gate Design	6-1606
N/A	71A-6 (71AM-6)	Standard Access Road Gate Design	6-1606
N/A	72-6 (72M-6)	Modified Yard Inlet (Single Throat)	6-1103.4
N/A	73-6 (73M-6)	Top Detail Modified Yard Inlet (Single Throat)	6-1103.4
N/A	74-6 (74M-6)	Modified Yard Inlet (Double Throat)	6-1103.4
N/A	75-6 (75M-6)	Top Detail Modified Yard Inlet (Double Throat)	6-1103.4
N/A	76-6 (76M-6)	Permissible Shear Stress Cohesive Soils	6-0203.5
N/A	77-6 (77M-6)	Permissible Shear Stress Non-cohesive Soils	6-0203.5
<u>N/A</u>	<u>78-6 (78M-6)</u>	<u>Porous Asphalt Pavement with Extended Aggregate Base</u>	<u>6-1304</u>
<u>N/A</u>	<u>79-6 (79M-6)</u>	<u>Permeable Open Joint Pavement Block</u>	<u>6-1304</u>
<u>N/A</u>	<u>80-6 (80M-6)</u>	<u>Example Inlet Schematic for Pervious Pavement</u>	<u>6-1304</u>
<u>N/A</u>	<u>81-6 (81M-6)</u>	<u>Reforested Area, Bioretention, or Vegetated Swale Sign</u>	<u>6-1307</u>
			<u>6-1311</u>
<u>N/A</u>	<u>82-6 (82M-6)</u>	<u>Bioretention Filter or Basin with Stone Storage</u>	<u>6-1307</u>

STANDARD DESIGNATION	PLATE NO.	DESCRIPTION	SECTION
<u>N/A</u>	<u>83-6 (83M-6)</u>	<u>Bioretention Filter</u>	<u>6-1307</u>
<u>N/A</u>	<u>84-6 (84M-6)</u>	<u>Bioretention Basin</u>	<u>6-1307</u>
<u>N/A</u>	<u>85-6 (85M-6)</u>	<u>Bioretention Filter or Basin (Outfall Daylighted)</u>	<u>6-1307</u>
<u>N/A</u>	<u>86-6 (86M-6)</u>	<u>Bioretention Filter &amp; Basin</u>	<u>6-1307</u>
<u>N/A</u>	<u>87-6 (87M-6)</u>	<u>Vegetated Swale with Check Dams</u>	<u>6-1308</u>
<u>N/A</u>	<u>88-6 (88M-6)</u>	<u>Vegetated Swale Grass without Check Dams</u>	<u>6-1308</u>
<u>N/A</u>	<u>89-6 (89M-6)</u>	<u>Vegetated Swale Plan and Profile</u>	<u>6-1308</u>
<u>N/A</u>	<u>90-6 (90M-6)</u>	<u>Tree Box Filter</u>	<u>6-1309</u>
<u>N/A</u>	<u>91-6 (91M-6)</u>	<u>Vegetated Roof - Extensive</u>	<u>6-1310</u>
<u>N/A</u>	<u>92-6 (92M-6)</u>	<u>Vegetated Roof - Intensive</u>	<u>6-1310</u>

### 6-1900 TABLES

STANDARD DESIGNATION	TABLE NO.	DESCRIPTION	SECTION
N/A	6.1	Hydrology – Small Private Drainage System	6-0204
N/A	6.2	Hydraulics – Small Private Drainage System	6-0204
N/A	6.3	Phosphorus Removal Efficiencies	6-0402
N/A	6.5	Acceptable Hydrologies – Applications	6-0801
N/A	6.6	Runoff Coefficients and Inlet Times	6-0805
N/A	6.7	Incremental Unit Hydrograph Intensities – Inches/Hour	6-0806
N/A	6.8	Minimum Easement Widths/Pipe Size	6-0902
N/A	6.9	Pipe and Culvert Materials – Roughness Coefficients	6-0903
RC-1	6.10	Radius of Curvature for Straight Deflected Pipe Length of 4' (1.2m)	6-0906
RC-1	6.11	Radius of Curvature for Straight Deflected Pipe Length of 6' (1.8m)	6-0906
RC-1	6.12	Radius of Curvature for Straight Deflected Pipe Length of 7 ½' (2.3m)	6-0906
RC-1	6.13	Radius of Curvature for Straight Deflected Pipe Length of 8' (2.4m)	6-0906
RC-1	6.14	Radius of Curvature for Straight Deflected Pipe Length of 10' (3m)	6-0906
RC-1	6.15	Radius of Curvature for Straight Deflected Pipe Length of 12' (3.6m)	6-0906
RC-1	6.16	Radius of Curvature for Straight Deflected Pipe Length of 16' (4.8m)	6-0906
N/A	6.16A	Minimum Easement Widths – Channels	6-1005.2E
N/A	6.17	Channel Materials – "n"	6-1006
N/A	6.18	Time of Concentration to Use – Paved Ditch	6-1010
N/A	6.22	Rainfall Distribution	6-1302.11
N/A	6.23	Storm Volume in Inches of Rainfall	6-1302
N/A	6.24	Mass Diagram Analysis	6-1303
N/A	6.25	2-Year Storm Routing	6-1305
N/A	6.26	10-Year Storm Routing	6-1305
N/A	6.27	General Ratings for Dams, Embankments and Reservoirs	6-1605
<u>N/A</u>	<u>6.28</u>	<u>Aggregate Gradation</u>	<u>6-1304.8B</u>
<u>N/A</u>	<u>6.29</u>	<u>Filter Fabric Specifications</u>	<u>6-1304.8F</u>
<u>N/A</u>	<u>6.30</u>	<u>Pretreatment Filter Strip Sizing</u>	<u>6-1307.4D</u>

STANDARD DESIGNATION	TABLE NO.	DESCRIPTION	SECTION
N/A	6.31	<u>Pretreatment Vegetated Channel Sizing</u>	6-1307.4D
N/A	6.32	<u>Compost Specifications</u>	6-1307.9A
N/A	6.33	<u>Soil Media Specifications</u>	6-1307.9A
N/A	6.34	<u>Filter Fabric Specifications</u>	6-1307.9D
N/A	6.35	<u>Channel Segment Length</u>	6-1308.5B
N/A	6.36	<u>Channel Cross-section Area</u>	6-1308.5C
N/A	6.37	<u>Example Problem</u>	6-1308.14B
N/A	6.38	<u>Granular Drainage Media Specifications</u>	6-1310.4D
N/A	6.39	<u>Filter Fabric Specifications</u>	6-1310.4E
N/A	6.40	<u>Growth Media Specifications</u>	6-1310.4F
N/A	6.41	<u>Mineral Fraction Grain-size Distribution for Intensive Sites</u>	6-1310.4F
N/A	6.42	<u>Mineral Fraction Grain-size Distribution for Extensive Sites</u>	6-1310.4F
N/A	6.43	<u>Bulk Densities That May Effect Root Growth</u>	6-1311.3G

**Amend PFM 6-0400 (STORMWATER RUNOFF QUALITY CONTROL CRITERIA) Section 6-0402 (Stormwater Quality Control Practices) Table 6.3 (Phosphorus Removal Efficiencies) to read as follows:**

**TABLE 6.3 PHOSPHORUS REMOVAL EFFICIENCIES**

BMP	Sizing Rule	Phosphorus <sup>1</sup> Removal (%)
Extended Detention <sup>2</sup> Dry Pond (48-hr)	Plate 2-6 (2M-6)	40
Wet Pond <sup>3</sup> Design 1 Design 2	2.5 x V <sub>r</sub> + extended detention 4.0 x V <sub>r</sub>	45 50
Infiltration <sup>4</sup> Design 1 Design 2 Design 3	0.5 in./impervious acre (32mm/impervious ha) 1.0 in./impervious acre (64mm/impervious ha) 2-yr, 2-hr storm	50 65 70
Natural Open Space <sup>5</sup>	N/A	100
Regional Ponds <sup>6</sup> Dry Pond Wet Pond	Plate 2-6 (2M-6) 4.0 x V <sub>r</sub>	50 65

Sand Filter <sup>7</sup>	0.5 in./impervious acre (32mm/impervious ha)	60
<u>Pervious Pavement</u> <sup>8</sup>	<u>Design 1</u>	<u>Captures and treats a water quality volume of 0.5 in (1.27 cm)</u>
		<u>without infiltration</u> 35
	<u>with infiltration</u> 50	
	<u>Design 2</u>	<u>Captures and treats a water quality volume of 1.0 in. (2.54 cm)</u>
<u>without infiltration</u> 40		
	<u>with infiltration</u> 65	
<u>Bioretention Basin/Filter</u>	<u>0.5 in./impervious acre (32mm/impervious ha)</u>	50
	<u>1.0 in./impervious acre (64mm/impervious ha)</u>	65
<u>Vegetated Swale</u>	<u>Volume Based Design</u>	
	<u>0.5 in./impervious acre (32mm/impervious ha)</u>	50
	<u>1.0 in./impervious acre (64mm/impervious ha)</u>	65
	<u>Flow Based Design</u>	
	<u>Hydraulic residence time of 18 minutes</u>	30
<u>Tree Box Filter</u>	<u>0.5 in./impervious acre (32mm/impervious ha)</u>	50
	<u>1.0 in./impervious acre (64mm/impervious ha)</u>	65
<u>Vegetated Roof</u> <sup>8</sup>	N/A	40
<u>Reforestation</u> <sup>9</sup>	N/A	70

<sup>1</sup>Phosphorus (as total P), the limiting nutrient for algal productivity in local receiving waters, is used as an indicator of water quality. Measures that control phosphorus also will control many other pollutants.

<sup>2</sup>A minimum drawdown time of 48 hr is required for the BMP storage volume.

<sup>3</sup>V<sub>r</sub> is the volume of runoff from the mean storm. It is computed based on an average annual rainfall of 40" (1016mm) per year and an average of 100 storms per year multiplied by the rational formula "C" factor. Design 1 incorporates extended detention above the permanent pool equal to the Plate 2-6 (2M-6) value.

<sup>4</sup>Infiltration may be used only on soils designated by a professional authorized by the State to provide such information as adequate for the purpose. Special attention must be given to construction and maintenance practices for infiltration.

<sup>5</sup>For purposes of BMP efficiencies, "open space" in residential areas is defined as perpetually undisturbed Homeowners Association (or "common") areas placed in floodplain or conservation easements and without other encumbrances. Full credit for utility easements equal to or less than 25' (7.6m) in width and which meet the above criteria is allowed. The Director may allow "open space" credit for undisturbed areas in utility easements greater than 25' (7.6m) in width on a case by case basis. Any areas located within private lots or with maintained landscaping or

active recreational areas are not to be included in "open space" determinations. In nonresidential areas, "open space" is defined as perpetually undisturbed areas placed in floodplain or conservation easements and without other encumbrances. Credit for utility easements equal to or less than 25' (7.6m) in width and which meet the above criteria is allowed. The Director may allow "open space" credit for undisturbed areas in utility easements greater than 25' (7.6m) in width on a case by case basis. Open space used for BMP credit which is not already in a floodplain easement shall be placed in a recorded conservation easement with metes and bounds which shall also be shown on the plat. BMP credit for open space, which is dedicated to the County during the land development process, may be assigned to the remaining portions of the original site on approval by the Board.

<sup>6</sup>Regional ponds are those facilities which are part of the regional stormwater management plan adopted by the Board or substitutes and additions to the plan approved by DPWES. All ponds for which regional BMP credit is requested must be approved by DPWES. Regional ponds generally control a watershed of 100 acres (40 ha) or more in size. However, the Director may allow regional BMP credit for smaller ponds constructed to satisfy requirements of the regional plan.

<sup>7</sup>Sand filters shall be privately owned and maintained.

<sup>8</sup>In applying the computational procedure in Chapter 4 of the Northern Virginia BMP Handbook to demonstrate compliance with the phosphorus removal requirement for the site, the "C" factor for pervious pavements and vegetated roofs should be set at 0.9 to correctly credit the phosphorus removal provided by these controls. This will result in a different weighted "C" factor than that used to compute stormwater runoff.

<sup>9</sup>In applying the computational procedure in Chapter 4 of the Northern Virginia BMP Handbook to demonstrate compliance with the phosphorus removal requirement for the site, the "C" factor ratio for reforestation should be set at 1.0 because reforestation is being treated as a land use credit rather than a structural control.

**Amend PFM 6-0800 (HYDROLOGIC DESIGN) Section 6-0805 (Other Hydrologies) Table 6.6 (Runoff Coefficients and Inlet Times) to read as follows:**

**TABLE 6.6 RUNOFF COEFFICIENTS AND INLET TIMES**

ZONING CLASSIFICATION	Runoff Coefficients	% Impervious	Inlet Times (minutes)
Business, Commercial & Industrial	0.80 – 0.90	90	5
Apartments & Townhouses	0.65 – 0.75	75	5 – 10
Schools & Churches	0.50 – 0.60	50	10 – 15 <sup>1</sup>
Single Family Units			
Lots 10,000 ft <sup>2</sup> (929 m <sup>2</sup> )	0.40 – 0.50	35	
Lots 12,000 ft <sup>2</sup> (1115 m <sup>2</sup> )	0.40 – 0.45	30	
Lots 17,000 ft <sup>2</sup> (1579 m <sup>2</sup> )	0.35 – 0.45	25	
Lots ½ acre (2023 m <sup>2</sup> ) or more	0.30 – 0.40	20	



Parks, Cemeteries and Unimproved Areas <sup>2</sup>	0.25 – 0.35	15	To be Computed
<u>TYPE OF SURFACE</u>			
<u>TYPE OF SURFACE</u> Pavements & Roofs	0.90	<u>100</u>	According to zoning classification of composite runoff coefficient
Lawns	0.25 – 0.35	<u>0</u>	
<u>Open Water</u> <sup>3,4</sup>	<u>0.9</u>	<u>0</u>	
<u>Reforested Areas</u> <sup>2</sup>	<u>0.25 – 0.35</u>	<u>0</u>	
<u>Vegetated Roofs</u> <sup>4</sup> <u>Extensive Systems</u> <u>Intensive Systems</u>	<u>0.50</u> <u>0.40</u>	<u>N/A</u> <sup>5</sup>	
<u>Pervious Pavement</u> <sup>4</sup> <u>Porous Asphalt Pavement</u> <u>Permeable Pavement Blocks</u>	<u>(I – 1.1) / I</u> <u>(I – 3.0) / I</u>  <u>I = peak rainfall intensity (in/hr)</u>	<u>N/A</u> <sup>5</sup>	

1) However, for design of yard inlets i.e., locations and throat capacities, in residential areas, drainage computations shall use a 5-minute time of concentration, or alternatively, a site specific calculation to justify usage of a longer time of concentration. Computations for design of pipes may continue to use the 10- to 15-minute time of concentration.

2) For unimproved areas and reforested areas containing less than 5% impervious cover and storm frequencies 2-yr or less, use C = 0.10 to 0.20.

3) The runoff coefficient for open water areas such as lakes and streams is set at 0.9 because all rainfall falling on open water is converted directly to runoff. For unimproved areas containing less than a total of 5% open water plus impervious cover, the open water areas may be ignored in computing composite runoff coefficients.

4) Composite runoff coefficients for drainage areas that include significant areas of open water, pervious pavements, or vegetated roofs should not be computed directly from the percentage of impervious area. Use the weighted average of the runoff coefficients to compute the runoff.

5) Values for percent imperviousness have not been assigned to pervious pavement and green roofs. For hydrologic purposes, they respond as pervious or partially pervious surfaces. In determining land use for application of Chesapeake Bay Preservation Ordinance development/redevelopment criteria, they are treated as impervious surfaces.

**Amend the title of PFM 6-1300 (RETENTION AND DETENTION FACILITIES) to read as follows:**

**6-1300 RETENTION, AND DETENTION, AND LOW IMPACT DEVELOPMENT FACILITIES**

**Amend PFM 6-01300 (RETENTION AND DETENTION FACILITIES) by deleting Section 6-1304 (Porous Asphalt Pavement) in its entirety and replacing it with new Section 6-1304 (Pervious Pavement) to read as follows:**

**6-1304 Pervious Pavement**

6-1304.1 Pervious pavement systems use a special asphaltic paving material (porous pavement) or open jointed concrete blocks (permeable pavement blocks) that allow stormwater to flow through the pavement or the open joints at a high rate. Water is temporarily retained below the pavement within an aggregate base and discharged to the storm sewer system or infiltrated into the underlying *in situ* soils. The principal components of pervious pavement systems are porous pavement or permeable pavement blocks, a bedding (choker) course, an optional filter fabric between the bedding course and the aggregate base in permeable pavement block systems, an open-graded aggregate base with a high void ratio, filter fabric to separate the aggregate base from the underlying soils and an underdrain that is connected to the storm drain system. Water quality control is provided by adsorption, filtering, sedimentation, biological action, and infiltration into the underlying soils. Pervious pavement systems reduce the peak rate and volume of stormwater runoff through detention storage and infiltration into underlying soils. Additional infiltration capacity or storage for detention can be obtained by increasing the depth of the aggregate base alone or in combination with storage chambers.

6-1304.1A Pervious pavement systems generally may be classified by the degree of infiltration into the underlying soils (i.e.

exfiltration out of the aggregate base) that the systems are designed to achieve.

6-1304.1A(1) No Exfiltration. Systems that do not rely on infiltration of the captured stormwater runoff into the underlying soils are designed to provide water quality control and detention of storm water runoff from small storms. Water that has passed through the pervious pavement is discharged to the storm drain system through an unrestricted underdrain.

6-1304.1A(2) Full or Partial Exfiltration. Systems that provide for full or partial infiltration of the captured stormwater runoff into the underlying soils are designed to provide water quality control and retention of storm water. Such systems rely on infiltration to drain down the water stored in the aggregate base between storms. Pervious pavement systems designed for exfiltration, as utilized in Fairfax County, generally include underdrains that are capped or have restricted outflow. This allows the system to continue to provide water quality control and detention, albeit at reduced levels, if the infiltration capacity of the *in situ* soils is reduced over time due to consolidation of the soil bed or clogging of the soil pores.

6-1304.1B Pervious pavement systems are applicable as a substitute for conventional asphalt or concrete pavement. Pervious pavement systems require reasonably favorable conditions of land slope, subsoil drainage, and groundwater table.

Pervious pavement systems are best suited to parking areas that are not subject to muddy conditions that cause sealing or clogging of the pervious material. Examples of suitable locations are parking areas for parks, churches, schools, office buildings, and shopping centers.

6-1304.1C For hydrologic computations using the Rational Method, the runoff coefficient ("C" factor) for porous pavement and permeable pavement block systems shall be computed based on the following formula:

$$C = (I - k_p) / I$$

Where:

I = design rainfall intensity (in/hr)  
k<sub>p</sub> = coefficient of permeability (in/hr)

Use a coefficient of permeability of 1.1 in/hr (27.9 mm/hr) for porous pavement and 3.0 in/hr (76.2 mm/hr) for permeable pavement block systems. For hydrologic computations using National Resource Conservation Service (NRCS) methods, use a Curve Number "CN" of 65 for porous pavement and 40 for permeable pavement block systems. For hydraulic computations, use a roughness coefficient ("n" value) of 0.01 for porous pavement and 0.03 for permeable pavement block systems.

## 6-1304.2 Location and Siting

6-1304.2A Pervious pavement systems may not be located in single family attached or detached residential developments for the purpose of satisfying the detention or water quality control (BMP) requirements of the Subdivision or Zoning Ordinance except as permitted under § 6-1304.2A(1) and § 6-1304.2A(2).

6-1304.2A(1) The Board of Supervisors (Board), in conjunction with the approval of a rezoning, proffered condition amendment, special exception, or special

exception amendment, may approve the location of pervious pavement systems in single family attached or detached residential developments in accordance with the following criteria:

6-1304.2A(1)(a) Any decision by the Board shall take into consideration possible impacts on the environment and the burden placed on prospective owners for maintenance of the facilities;

6-1304.2A(1)(b) Pervious pavement must be part of an overall stormwater management design that does not rely exclusively on pervious pavement to meet water quality control (BMP) and detention requirements;

6-1304.2A(1)(c) Adequate funding for maintenance of the facilities shall be provided by the applicant where deemed appropriate by the Board;

6-1304.2A(1)(d) Pervious pavement facilities must be located on Home Owner Association (or "common") property and may not be located on individual buildable single family attached or detached residential lots, or any part thereof;

6-1304.2A(1)(e) Pervious pavement facilities shall be privately maintained and a private maintenance agreement in a form acceptable to the Director, which may include but is not limited to requirements for third-party inspections and the filing of annual maintenance and inspection reports with the County, must be executed before the construction plan is approved;

6-1304.2A(1)(f) The use of and responsibility for maintenance of pervious pavement facilities shall be disclosed as part of the chain of title to all future homeowners (e.g. individual members of a homeowners association) responsible for maintenance of the facilities; and

6-1304.2A(1)(g) In addition to the above requirements, reasonable and appropriate conditions may be imposed, where

deemed appropriate by the Board, to provide for maintenance of the facilities and disclosure to property owners.

6-1304.2A(2) Pervious pavement systems may be located in single family attached or detached residential developments if the pervious pavement appears as a feature shown on a proffered development plan or a special exception plat approved prior to March 12, 2007.

6-1304.2B Pervious pavement systems may not be located on individual residential lots for the purpose of satisfying the water quality control (BMP) requirements of the Chesapeake Bay Preservation Ordinance.

6-1304.2C Pervious pavement systems that utilize infiltration may not be constructed on fill material.

6-1304.2D Pervious pavement systems may not be constructed in areas where the adjacent slopes are steeper than 20%.

6-1304.2E The slope of pervious pavement systems shall be from 1 to 5 percent.

6-1304.2F Setbacks. Pervious pavement systems not designed for infiltration into the underlying *in situ* soils shall be located a minimum of 10 feet (3 m) horizontally from building foundations preferably down gradient. Pervious pavement systems designed for infiltration into the underlying *in situ* soils shall be located a minimum of 20 feet (6 m) horizontally from building foundations preferably down gradient. Pervious pavement systems shall be located a minimum of 100 feet (30 m) horizontally from water supply wells. Pervious pavement systems not designed for infiltration shall be located a minimum of 25 feet (7.5 m) horizontally up gradient from septic fields and a minimum of 50 feet (15 m) horizontally down gradient from septic fields. Pervious pavement systems designed for infiltration shall be

located a minimum of 50 feet (15 m) horizontally from septic fields preferably up gradient.

6-1304.2G The maximum flow length of impervious or pervious surfaces draining onto pervious pavement shall be 100 feet (30 m).

6-1304.2H The total drainage area to the pervious pavement shall not be greater than 5 acres (2.0 hectares).

6-1304.2H(1) The maximum ratio of impervious areas to the area of porous pavement for facilities designed to capture and treat a water quality volume of 0.5 inches (1.27 cm) is 3.4:1. The maximum ratio of impervious areas to the area of porous pavement for facilities designed to capture and treat a water quality volume of 1.0 inch (2.54 cm) is 1.2:1.

6-1304.2H(2) The maximum ratio of impervious areas to the area of permeable pavement blocks for facilities designed to capture and treat a water quality volume of 0.5 inches (1.27 cm) is 11:1. The maximum ratio of impervious areas to the area of permeable pavement blocks for facilities designed to capture and treat a water quality volume of 1.0 inch (2.54 cm) is 5:1.

6-1304.2I Pervious pavement systems shall not be located in the vicinity of loading docks, vehicle maintenance areas, or outdoor storage areas, where there is the potential for high concentrations of hydrocarbons, toxics, or heavy metals in stormwater runoff entering the facility.

6-1304.2J Pervious pavement systems shall not be located in travelways, areas subject to frequent truck traffic or material storage areas, such as loading docks, where there is potential for settling or high loads of grease and oils.

6-1304.2K Concentrated flow shall not be discharged directly onto pervious pavement.

6-1304.2L For pervious pavement systems utilizing open jointed concrete blocks, handicapped parking spaces and associated pathways shall utilize concrete blocks without open joints.

6-1304.3 Maintenance. Pervious pavement systems must be privately maintained and a private maintenance agreement must be executed before the construction plan is approved. The above does not preclude the use of pervious pavement by the County on County owned property. County maintained storm and sanitary sewer lines and their easements may be routed through areas of privately maintained pervious pavement.

#### 6-1304.4 General Design Requirements.

6-1304.4A Water Quality Volume. For facilities designed to capture and treat the first 0.5 inches (1.27 cm) of runoff, the required water quality volume is 1,815 cubic feet per acre (127 m<sup>3</sup>/ha) multiplied by the sum of the impervious area draining to the pervious pavement plus the area of the pervious pavement. For facilities designed to capture and treat the first 1.0 inch (2.54 cm) of runoff, the required water quality volume is 3,630 cubic feet per acre (254 m<sup>3</sup>/ha) multiplied by the sum of the impervious area draining to the pervious pavement plus the area of the pervious pavement. The water quality volume must be filtered through the pavement to receive credit.

6-1304.4B Detention. For facilities designed to provide detention, the 2-year 2-hour storm and the 10-year 2-hour storm must be routed through the facility or the facility may be designed to infiltrate the 10-year 2-hour storm volume. Routings shall be performed in accordance with § 6-1300 *et seq.* Inlets shall be provided or the aggregate base extended 2 feet (0.6 meters) beyond the edge of the pavement to convey stormwater in excess of the water quality volume to the aggregate base or storage chambers below the pervious pavement.

6-1304.4C For facilities designed to provide detention, the maximum water surface elevation for the 10-year 2-hour storm shall be a minimum of 0.5 feet (152 mm) below the pavement bedding course.

6-1304.4D The detention release rate shall be controlled by a valve or cap on the end of the pavement underdrain within the structure.

6-1304.4E Pretreatment. Pretreatment for areas that sheet flow onto the pavement is not required. Inlets shall be designed to provide pretreatment of stormwater to prevent debris and sediments from entering the aggregate base or storage chambers. Where the aggregate base is extended beyond the edge of the pavement to convey stormwater to the aggregate base, an additional layer of filter fabric shall be provided 1 foot (305 mm) below the surface to prevent sediments from getting into the aggregate base.

6-1304.4F Underdrains shall be provided for all pervious pavement systems. The outfall of all underdrains must be in conformance with the adequate drainage requirements of § 6-0200 *et seq.*

6-1304.4G The bottom of the facility shall be a minimum of 4 feet (1220 mm) above the groundwater table and bedrock for facilities designed to provide infiltration and a minimum of 2 feet (610 mm) above the groundwater table and bedrock for all other facilities as determined by field run soil borings. The bottom of the facility shall be below the frost line to prevent frost heave of the pavement.

6-1304.4H For facilities designed to provide infiltration, the underdrain shall be restricted as necessary so that the design infiltration rate plus the underdrain outflow rate equals the design draw down rate. The restriction shall be achieved by using an end cap with a hole to act as an orifice or a valve fitted onto the end of the underdrain. Alternatively, a flow control satisfactory to the Director may be

provided within the outflow structure. See § 6-1604.1A(2) for orifice calculations. The minimum diameter of any orifice shall be 0.5 inch (13 mm). Facilities shall be designed to dewater completely within 24 hours. If the facility can drain in the required time without any outflow through the underdrain, the end cap may be provided without a hole.

6-1304.4I For facilities utilizing infiltration, a soils analysis shall be prepared and infiltration tests conducted by a licensed professional engineer with experience in geotechnical engineering and soil evaluation, a certified professional soil scientist, or a certified professional geologist. Recommended guidelines for performing the field tests and soils analysis are available from the Department of Public Works and Environmental Services. A minimum field measured infiltration rate of 0.52 inches per hour (13.2 mm/hr) shall be required for infiltration. The design infiltration rate shall be half of the field measured rate. Soils with a CBR (minimum 96 hours soaked) less than 5 or that are highly expansive are not suitable for infiltration. Such soils would require compaction or other measures to be used as a pavement subgrade that would compromise their ability to infiltrate water. Pervious pavements on these soils shall be designed for no infiltration with unrestricted underdrains.

6-1304.4J Permeable pavement block systems require edge restraints to prevent movement of the pavement blocks from vehicle loads. Edge restraints may be standard VDOT curbs, standard VDOT combination curb and gutters, or precast or cast in place reinforced concrete borders a minimum 6 inches (152 mm) wide and 18 inches (457 mm) deep constructed with Class A3 concrete. Edge restraints shall be installed flush with the paver blocks.

6-1304.4K Side slopes of the facility excavated below ground may be as steep as the *in situ* soils will permit. The

bottom of the excavated bed shall be level or nearly level. All excavation must be performed in accordance with Virginia Occupational Safety and Health (VOSH) requirements. If the facility is located on problem soils (such as marine clays), a geotechnical engineer shall specify the maximum acceptable slope for the excavation.

6-1304.4L Variations of the pervious pavement designs in Plates 78-6, 79-6, and 80-6 (78M-6, 79M-6, & 80M-6) may be approved by the Director provided the facility meets all of the requirements in § 6-1304 *et seq.*

6-1304.5 Pervious Pavement Design.

6-1304.5A Because there is no above ground storage of stormwater runoff, the minimum area of the pervious pavement required to infiltrate the water quality volume into the aggregate base is governed by the permeability of the pavement. The minimum area of the pervious pavement is computed as follows:

$$A_p = (WQ_v) / [(k_p/12)(t_s)]$$

Where:

$A_p$  = area of pervious pavement (ft<sup>2</sup>)  
 $WQ_v$  = water quality volume (ft<sup>3</sup>)  
 $k_p$  = coefficient of permeability (in/hr)  
 $t_s$  = time base of design storm (hrs)

6-1304.5B For design purposes, the permeability of the pavement is 1.1 in/hr (27.9 mm/hr) for porous pavement and 3.0 in/hr (76.2 mm/hr) for permeable pavement block systems and the time base of the design storm is 2 hours. After incorporating these values, the above equation reduces to:

$$A_p = 5.455 \times WQ_v \text{ for porous pavement}$$
$$A_p = 2.0 \times WQ_v \text{ for permeable pavement block systems}$$

6-1304.6 Aggregate Base/Storage Chamber Design.

6-1304.6A Storage Volume. Storage for detention or infiltration may be provided by a layer of aggregate or aggregate in combination with storage chambers beneath the pervious pavement. Water flows into the storage layer either through an inlet structure or through the pavement. Water flows out of the storage layer either by infiltration into the underlying *in situ* soils or through a restricted underdrain. The design objectives are to infiltrate as much of the water as possible, to assure that there is complete drain down of the facility between storms, to meet the structural requirements for the pavement design, and to meet the physical constraints of the site.

6-1304.6A(1) For facilities designed to infiltrate the water quality volume, the amount of storage required is based on water quality volume minus the infiltration rate into the underlying *in situ* soils and the outflow through the underdrain during the 2 hour filling period. The required storage volume is computed as follows:

$$V_s = WQ_v - [(k_s)(A_s)(t_s)/12] - [3600(Q_u)(t_s)]$$

Where:

- $V_s$  = volume of storage (ft<sup>3</sup>)
- $WQ_v$  = water quality volume (ft<sup>3</sup>)
- $k_s$  = soil infiltration rate (in/hr)
- $A_s$  = area of soil bed (ft<sup>2</sup>)
- $t_s$  = time base of design storm (hrs)
- $Q_u$  = outflow through underdrain (cfs)

6-1304.6A(2) For facilities designed to provide detention in addition to treating the water quality volume, the water quality volume is replaced in the above equation by the total storm runoff volume for the design storm ( $V_{ds}$ ). The required storage volume is computed as follows:

$$V_s = V_{ds} - [(k_s)(A_s)(t_s)/12] - [3600(Q_u)(t_s)]$$

6-1304.6B Storage Depth. Typically, the area of the soil bed will be known and the

depth of the aggregate layer will be computed from the required storage and the porosity of the aggregate as follows:

For facilities designed to treat only the water quality volume:

$$d_g = V_s / [(n_g)(A_s)]$$

For facilities designed to provide detention add 0.5 feet (152 mm) to the above to provide the required separation (§ 6-1304.4C) between the bedding layer and the 10-year water surface elevation:

$$d_g = V_s / [(n_g)(A_s)] + 0.5$$

Where:

- $d_g$  = depth of aggregate layer (ft)
- $V_s$  = volume of storage (ft<sup>3</sup>)
- $n_g$  = porosity of aggregate
- $A_s$  = area of soil bed (ft<sup>2</sup>)

The depth of the aggregate layer does not include the thickness of the bedding layer. For volume calculations, use a porosity of 0.40 for VDOT #2, #3, and #57 stone.

6-1304.6C Check the computed depth of the aggregate layer against the required depth for installation of the underdrain system [4 inches (102 mm) plus the diameter of the largest underdrain pipe] and the required depth of the pavement subbase (see § 7-0500 *et seq.*). The minimum required depth will be the greatest of these three values.

6-1304.6D Check the invert elevation of the aggregate layer against the elevation of the water table and bedrock. Also check that the facility can drain to the intended outfall.

6-1304.6E Facility Drain Time. The final step in the design of the aggregate layer is to compute the time that it takes the facility to drain. The facility must drain completely within 24 hours. The drain time is computed as follows:

$$t_d = V_s / [(k_s)(A_s)/12 + 3600(Q_u)]$$

Where:

$t_d$  = total drain time for facility (hrs)  
 $V_s$  = volume of storage (ft<sup>3</sup>)  
 $k_s$  = soil infiltration rate (in/hr)  
 $A_s$  = area of soil bed (ft<sup>2</sup>)  
 $Q_u$  = outflow through underdrain (cfs)

6-1304.6F For facilities designed with unrestricted underdrains, computation of the storage volume, storage depth, and facility drain time are not necessary. However, it is still necessary to check the depth of the aggregate layer against the required depth for the pavement sub-base and the invert elevation of the bottom of the aggregate layer against the elevation of the water table, bedrock, and the intended outfall.

6-1304.6G For facilities designed to provide infiltration, the infiltration rate into the underlying *in situ* soils typically will be less than the flow rate through the pavement and the outflow through the underdrain will be restricted or absent such that some storage will be required. In performing computations of the storage volume, storage depth, and facility drain time, initially assume that the underdrain is capped and there is no outflow through the underdrain. If the allowable depth of the storage layer based on the elevation of the groundwater table or bedrock is insufficient to provide the necessary storage volume, storage may be increased by increasing the area of the aggregate layer and soil bed or by incorporating storage chambers. Alternatively, the underdrain may be provided with an orifice to decrease the amount of storage needed. If the total drain time of the facility is in excess of 24 hours, it will be necessary to increase the area of the aggregate base and soil bed or provide an orifice and recompute the total drain time through the facility. Outflow through the orifice may not exceed the pre-development peak flow rates for the 2-year and 10-year storms.

6-1304.7 Underdrains. Underdrains shall consist of perforated pipe  $\geq$  4 inch (102 mm) in diameter placed in a layer of washed VDOT #57 stone. VDOT #2 or #3 stone may be substituted for #57 stone when #2 or #3 stone is used for the aggregate base. There shall be a minimum of 2 inches (51 mm) of aggregate above and below the pipe. Laterals shall be a minimum of 4-6 inches (102-152 mm) in diameter. Main collector lines and manifolds shall be a minimum of 6-8 inches (152-203 mm) in diameter. Underdrains shall be laid at a minimum slope of 0.5%. Underdrains shall have a maximum internal spacing of 20 feet (6 m) on center and extend to within 10 feet (3 m) of the perimeter of the aggregate base. Underdrains not terminating in an observation well/clean-out shall be capped. Underdrain pipe connected to structures shall be nonperforated within 1 foot (305 mm) of the structure. Cleanouts and observation wells shall be nonperforated within 1 foot (305 mm) of the surface. All stone shall be washed with less than 1% passing a #200 sieve.

6-1304.8 Materials Specifications.

6-1304.8A Open jointed concrete blocks shall have a minimum thickness of 3 1/8 inches (80 mm) and conform to ASTM C 936-01 Standard Specification for Solid Concrete Interlocking Pavement Units. Joint openings shall be a minimum of 10% of the surface area of the pavement after installation. Joint openings shall be filled with VDOT #8, #8P, or #9 stone. VDOT #8 stone is recommended. VDOT #8P or #9 stone may be used where needed to fill narrow joints. All stone shall be washed with less than 1% passing a #200 sieve.

6-1304.8B Porous asphalt pavement shall be a minimum of 2.5 inches (64 mm) thick and conform to VDOT Road and Bridge Specifications for Asphalt Materials (Section 210) and Asphalt Cement (Section 211) except for aggregate gradation. The asphalt mix shall be 5.75% to 6.0% of dry aggregate by weight. The asphalt binder shall be modified with an



elastomeric polymer to produce a binder meeting the requirements of PG 76-22 (AASHTO MP-1) and applied at a rate of 3.0% by total weight of the binder. Drain down of the asphalt binder shall be no greater than 0.3% (ASTM D 6390). The aggregate gradation shall be as specified in Table 6.28. Porous asphalt pavement shall have a minimum connected void space of 18%.

Table 6.28 Aggregate Gradation

U.S. Standard Sieve Size	Percent Passing
1/2 in (12.5 mm)	100
3/8 in (9.5 mm)	92-98
#4 (4.75 mm)	34-40
#8 (2.36 mm)	14-20
#16 (1.18 mm)	7-13
#30 (0.60 mm)	0-4
#200 (0.075 mm)	0-2

6-1304.8C The bedding course for open jointed pavement blocks shall consist of 1.5 to 3.0 inches (38-76 mm) of washed VDOT #8, #8P, or #9 stone. VDOT #8 stone is recommended. VDOT #8P or #9 stone may be used to match the stone used in the joint openings. The thickness of the bedding course is to be based on the block manufacturer's recommendation. The bedding course for porous asphalt pavement shall consist of 1.0 to 2.0 inches (25-51 mm) of washed VDOT #57 stone. All stone shall be washed with less than 1% passing a #200 sieve.

6-1304.8D The aggregate base course shall consist of washed VDOT #57 stone. The thickness of the base course is determined by runoff storage needs, the infiltration rate of *in situ* soils, structural requirements of the pavement sub-base, depth to watertable and bedrock, and frost depth conditions. VDOT #2 or #3 stone may be substituted as the base course material provided an adequate choker course of VDOT #57 stone is provided between the aggregate base course and the bedding course. All stone

shall be washed with less than 1% passing a #200 sieve.

6-1304.8E Underdrains shall be PVC pipe conforming to the requirements of ASTM F758, Type PS 28 or ASTM F949; HDPE pipe conforming to the requirements AASHTO M252 or M 294, Type S; or other approved rigid plastic pipe with a smooth interior. Underdrains shall be perforated with 4 rows of 3/8 inch (9.5 mm) holes with a hole spacing of  $3.25 \pm 0.25$  inches ( $82.5 \pm 6.4$  mm) or a combination of hole size and spacing that provides a minimum inlet area  $\geq 1.76$  square inches per linear foot ( $37.2 \text{ cm}^2/\text{m}$ ) of pipe or be perforated with slots 0.125 inches (3.2 mm) in width that provides a minimum inlet area  $\geq 1.5$  square inches per linear foot ( $31.8 \text{ cm}^2$  per linear meter) of pipe.

6-1304.8F Filter fabric. Filter fabric shall be a needled, non-woven, polypropylene geotextile meeting the requirements listed in Table 6.29. Heat-set or heat-calendared fabrics are not permitted.

Table 6.29 Filter Fabric Specifications

Grab Tensile Strength (ASTM D4632)	$\geq 120$ lbs (534 N)
Mullen Burst Strength (ASTM D3786)	$\geq 225$ lbs/in <sup>2</sup> (1550 kPa)
UV Resistance (ASTM D4355)	70% strength after 500 hours
Flow Rate (ASTM D4491)	$\geq 125$ gal/min/ft <sup>2</sup> (5093 l/min/m <sup>2</sup> )
Apparent Opening Size (AOS) (ASTM D4751)	US #70 or #80 sieve (0.212 or 0.180 mm)

6-1304.9 Construction Specifications.

6-1304.9A The owner shall provide for inspection during construction of the facility by a licensed professional (In accordance with standard practice, the actual inspections may be performed by an individual under responsible charge of the licensed professional). The licensed professional shall certify that the facility

was constructed in accordance with the approved plans. The licensed professional's certification along with any material delivery tickets and certifications from the material suppliers and results of the inspections required under § 6-1304.9G(11) or § 6-1304.9H(6) and § 6-1304.9H(7) shall be submitted to the County prior to bond release. For projects requiring as-built plans, the required certification and supporting documents shall be submitted with or incorporated in the as-built plans. For projects that do not require as-built plans, the required certification and supporting documents shall be submitted with the RUP or non-RUP request.

6-1304.9B Pervious pavement facilities shall be constructed after the drainage area to the facility is completely stabilized. Erosion and sediment controls for construction of the facility shall be installed as specified in the erosion and sediment control plan. Preliminary grading of the area where pervious pavement is to be installed may be performed at the time the rest of the site is mass graded provided that positive drainage is maintained and the area is stabilized. For pervious pavement applications that will utilize infiltration, preliminary grading shall be a minimum of 2 feet (0.6 m) above the final design elevation of the bottom of the aggregate base and the area shall be immediately stabilized with no further construction traffic until the pervious pavement is installed.

6-1304.9C Areas where pervious pavement is to be installed should not be used for temporary sediment basins. Where unavoidable, the invert of the sediment basin shall be a minimum of 2 feet (0.6 m) above the final design elevation of the bottom of the aggregate base.

6-1304.9D For facilities designed for full or partial exfiltration, the floor of the facility shall be scarified to a minimum depth of 6 inches (152 mm) to reduce soil

compaction and leveled before the filter fabric and stone are placed. Any areas of the facility where a temporary sediment basin was located also shall have 2 to 3 inches (51-76 mm) of sand incorporated into the *in situ* soils.

6-1304.9E Filter fabric shall be placed on the bottom and sides of the facility. Strips of fabric shall overlap by a minimum of 2 feet (0.6 m). Fabric shall be secured minimum of 4 feet (1.2 m) beyond the edge of the excavation. Following placement of the aggregate and again after placement of the pavement or pavers, the filter fabric should be folded over placements to protect installation from sediment inputs. Excess filter fabric should not be trimmed until the site is fully stabilized.

6-1304.9F After installation of the filter fabric over the soil subgrade, a 2 inch (51 mm) lift of aggregate shall be placed for the underdrain bedding. Underdrain piping shall be installed and sufficient aggregate shall be placed around and over the underdrain pipe to prevent damage to the pipe prior to compaction. Aggregate shall be placed in 4 to 8 inch (102-203 mm) lifts and compacted with a static roller. At least 4 passes should be made with a minimum 10-ton (9 T) static roller. The initial passes of the roller can be with vibration to consolidate the base material. The final passes should be without vibration. No visible movement should occur in the base material when compaction is complete.

6-1304.9G Installation of open jointed pavement blocks.

6-1304.9G(1) The bedding course shall be placed in a single lift. The bedding course shall be leveled and pressed (choked) into the aggregate base with at least 4 passes of a 10 ton (9 T) steel drum static roller. The bedding material should be moist to facilitate movement into the aggregate base. [Note: Install optional filter fabric per engineer's specifications prior to placement of bedding course.]

6-1304.9G(2) Edge restraints for open jointed pavement blocks shall be in place prior to installation of the bedding course and pavement blocks.

6-1304.9G(3) Prior to placement of the pavers,  $\frac{3}{4}$  to 1 inch (19-25 mm) of the compacted bedding material shall be loosened and smoothed to an even surface.

6-1304.9G(4) Pavers may be placed by hand or with mechanical installers. Compact and seat pavers into the bedding material with a low amplitude 5000 lb-ft (22 kN), 75 to 95 Hz plate compactor.

6-1304.9G(5) Gaps at the edge of the paved areas shall be filled with cut pavers or edge units. When required, pavers shall be cut with a paver splitter or masonry saw. Cut pavers shall be no smaller than  $\frac{1}{3}$  of the full unit size.

6-1304.9G(6) Fill the openings and joints with aggregate until it is within  $\frac{1}{2}$  inch (13 mm) of the top surface. Remove excess aggregate by sweeping pavers clean. Compact the pavers again, vibrating the aggregate into the openings. Apply additional aggregate to the openings and joints, filling them completely. Remove excess aggregate by sweeping and compact the pavers. This will require at least 2 passes with the compactor.

6-1304.9G(7) Do not compact within 3 feet (0.9 m) of the unrestrained edges of the pavers.

6-1304.9G(8) The system must be thoroughly swept to remove any sediment or excess aggregate immediately after construction.

6-1304.9G(9) Proof roll the surface after installation is complete.

6-1304.9G(10) The area shall be inspected for settlement. Any blocks that settle shall be reset and re-inspected.

6-1304.9G(11) The facility shall be inspected at 18-30 hours after a significant rainfall [0.5-1.0 inch (1.27-2.54 cm)] or artificial flooding to determine that the facility is draining properly.

6-1304.9H Installation of porous asphalt pavement.

6-1304.9H(1) The choker course shall be placed in a single lift. The choker course shall be leveled and pressed (choked) into the aggregate base with at least 4 passes of a 10 ton (9 T) steel drum static roller. The choker course material should be moist to facilitate movement into the aggregate base.

6-1304.9H(2) Porous asphalt pavement is installed similarly to regular asphalt pavement. The pavement shall be laid in a single lift over the choker course. The laying temperature shall be between 230°F and 260°F, with a minimum air temperature of 50°F, to make sure that the surface does not stiffen before compaction.

6-1304.9H(3) Compaction of the surface course should be completed when the surface is cool enough to resist a 10-ton roller. One or two passes of the roller are required for proper compaction. More rolling could cause a reduction in the porosity of the pavement.

6-1304.9H(4) The mixing plant shall certify to the aggregate mix, the abrasion loss factor, and the asphalt content in the mix. The asphalt mix shall be tested for its resistance to stripping by water using ASTM 1664. If the estimated coating area is not above 95%, additional antistripping agents shall be added to the mix.

6-1304.9H(5) The mix shall be transported to the site in a clean vehicle with smooth dump beds sprayed with a non-petroleum

release agent. The mix shall be covered during transportation to control cooling.

6-1304.9H(6) The full permeability of the pavement surface shall be tested by application of clean water at a rate of at least 5 gpm (19 lpm) over the surface. All water must infiltrate directly without puddle formation or surface runoff.

6-1304.9H(7) The facility shall be inspected at 18-30 hours after a significant rainfall [0.5-1.0 inch (1.27-2.54 cm)] or artificial flooding to determine that the facility is draining properly.

#### 6-1304.10 Plan Submission Requirements

6-1304.10A Plan view(s) with topography showing all hydraulic structures including underdrains.

6-1304.10B Cross section(s) of the facility with elevations showing the following as required: elevations and dimensions of inlet, outlet, underdrain, pavement course, bedding course, choker course, aggregate base, storage chambers, filter fabric, groundwater table, and bedrock.

6-1304.10C Sizing computations for the facility including volume of storage and surface area of the facility required and provided.

6-1304.10D Hydrologic calculations for the facility.

6-1304.10E Infiltration calculations as appropriate.

6-1304.10F Soils analysis and testing results for facilities that utilize infiltration including the elevation of the groundwater table and bedrock.

6-1304.10G A discussion of the outfalls from the facility is to be included in the outfall narrative.

6-1304.10H Construction and materials specifications.

#### 6-1304.11 Pervious Pavement Design Example:

6-1304.11A Given:

Parking lot area = 20,000 ft<sup>2</sup>;

Area of regular pavement ( $A_i$ ) = 10,000 ft<sup>2</sup>;

Area of porous asphalt pavement ( $A_p$ ) = 10,000 ft<sup>2</sup>;

Coefficient of permeability of porous asphalt pavement ( $k_p$ ) = 1.1 in/hr

Design infiltration rate of *in situ* soils ( $k_s$ ) = 0.26 in/hr (one-half of field measured rate of 0.52 in/hr);

Porosity of gravel ( $n_g$ ) = 0.40

6-1304.11B Determine the required area of the porous asphalt pavement ( $A_p$ ) for a water quality volume ( $WQ_v$ ) of 1.0 inch per acre (3,630 ft<sup>3</sup>) of impervious pavement plus 1.0 inch per acre (3,630 ft<sup>3</sup>) of porous asphalt pavement. For design purposes, assume that the water quality volume can flow through the pervious pavement without surface runoff.

6-1304.11B(1) The water quality volume is:

$$WQ_v = 3,630 \text{ ft}^3 (20,000 \text{ ft}^2 / 43,560 \text{ ft}^2) \\ = 1,667 \text{ ft}^3$$

6-1304.11B(2) The required area of the porous asphalt pavement is:

$$A_p = 5.455 \times WQ_v \\ = 5.455 \times 1667 = 9,094 \text{ ft}^2$$

Area provided 10,000 ft<sup>2</sup>  $\geq$  9,094 ft<sup>2</sup> OK

Note that as long as the ratio of impervious area to porous asphalt pavement meets the requirements of § 6-1304.2G [ $\leq$  3.4:1 for a water quality volume of 0.5 inches and  $\leq$  1.2:1 for a water quality volume of 1.0 inch], the area of the porous asphalt pavement will be sufficient to treat the water quality volume. In this example the ratio of impervious area to pervious pavement is 1:1.

6-1304.11C Determine the required storage volume ( $V_s$ ) and depth ( $d_g$ ) of the gravel layer to provide for infiltration of the entire water quality volume ( $WQ_v$ ) [ $1,667 \text{ ft}^3$ ]. The design infiltration rate ( $k_s$ ) is equal to half of the field measured rate of 0.52 in/hr. Assume that the area of the soil bed ( $A_s$ ) is equal to the area of the porous asphalt pavement ( $A_p$ ). Ignore any additional storage that may be provided by the underdrain pipes and assume that there is no outflow ( $Q_u$ ) through the underdrain.

6-1304.11C(1) The required storage volume is:

$$\begin{aligned} V_s &= WQ_v - [(k_s)(A_s)(t_s)/12] - [3600(Q_u)(t_s)] \\ &= 1667 - [0.26(10000)(2)/12] - 0 \\ &= 1233.7 \text{ ft}^3 \end{aligned}$$

Use:  $V_s = 1,234 \text{ ft}^3$

6-1304.11C(2) Compute the depth of the gravel storage area for a soil bed area of  $10,000 \text{ ft}^2$  and a storage volume of  $1,234 \text{ ft}^3$ .

$$\begin{aligned} d_g &= V_s / [(n_g)(A_s)] \\ &= 1234 / [(0.40)(10,000)] \\ &= 0.31 \text{ ft} \end{aligned}$$

6-1304.11C(3) Check the computed depth of the aggregate layer against the required depth for installation of the underdrain system and the required depth of the pavement subbase. The minimum required depth will be the greatest of these three values.

Check the depth between the bottom of the gravel storage area and the groundwater table and bedrock elevations from soil borings. Also check that the facility can drain to the intended outfall.

6-1304.11C(4) Compute the total drain time for the facility for a soil bed area of  $10,000 \text{ ft}^2$  and a storage volume of  $1,667 \text{ ft}^3$  (Must be less than 24 hrs.).

$$\begin{aligned} t_d &= V_s / [(k_s)(A_s)/12 + 3600(Q_u)] \\ &= 1667 / [(0.26)(10,000)/12 + 0] \\ &= 7.7 \text{ hrs} \leq 24 \text{ hrs OK} \end{aligned}$$

6-1304.11D Redesign the facility to provide detention of the 10-year 2-hour storm in addition to water quality control and to maximize infiltration. Note that an inlet or an extension of the aggregate base beyond the edge of the pavement will be required to deliver the storm volume in excess of the water quality volume ( $1,667 \text{ ft}^3$ ) to the gravel storage layer. The 10-year 2-hour storm volume is 3 inches per acre ( $10,890 \text{ ft}^3$ ) of impervious pavement and 3 inches per acre ( $10,890 \text{ ft}^3$ ) of porous asphalt pavement. Assume the gravel storage layer fills in 2 hours and that there is no outflow through the orifice during the filling period.

6-1304.11D(1) The 10-year 2-hour storm volume is:

$$\begin{aligned} V_{10} &= 10,890 \text{ ft}^3 (20,000 \text{ ft}^2 / 43,560 \text{ ft}^2) \\ &= 5,000 \text{ ft}^3 \end{aligned}$$

6-1304.11D(2) Determine the required storage volume ( $V_s$ ).

$$\begin{aligned} V_s &= V_{10} - [(k_s)(A_s)(t_s)/12] - [3600(Q_u)(t_s)] \\ &= 5000 - [0.26(10,000)(2)/12] - 0 \\ &= 4,567 \text{ ft}^3 \end{aligned}$$

6-1304.11D(3) Compute the depth of the gravel storage area for a soil bed area of  $10,000 \text{ ft}^2$  and a storage volume of  $4,567 \text{ ft}^3$ .

$$\begin{aligned} d_g &= V_s / [(n_g)(A_s)] + 0.5 \\ &= 4567 / [(0.40)(10,000)] \\ &= 1.64 \text{ ft} \end{aligned}$$

Check the depth between the bottom of the gravel storage area and the groundwater table and bedrock elevations from soil borings. If 1.64 ft is too deep, adjust the depth by providing additional storage in pipes or chambers or by enlarging the footprint of the facility.

6-1304.11D(4) Compute the total drain time for the facility for a soil bed area of

10,000 ft<sup>2</sup> and a storage volume of 4,567 ft<sup>3</sup> (Must be less than 24 hrs.).

$$\begin{aligned} t_d &= V_s / [(k_s)(A_s) / 12 + 3600(Q_u)] \\ &= 4567 / [(0.26)(10,000) / 12 + 0] \\ &= 21.1 \text{ hrs} \leq 24 \text{ hrs OK} \end{aligned}$$

6-1304.11E As a final example, assume that there is no infiltration into the *in situ* soils and we want to address an inadequate outfall by providing maximum detention of the 10-year storm. This will require that the entire 10-year storm volume be stored in the gravel storage layer and an orifice be designed for the underdrain system to keep the total drain time for the facility to less than 24 hrs.

6-1304.11E(1) Compute the depth of the gravel storage area for a soil bed area of 10,000 ft<sup>2</sup> and a storage volume of 5,000 ft<sup>3</sup>.

$$\begin{aligned} d_g &= V_s / [(n_g)(A_s)] + 0.5 \\ &= 5000 / [(0.40)(10,000)] \\ &= 1.75 \text{ ft} \end{aligned}$$

Check the depth between the bottom of the gravel storage area and the groundwater table and bedrock elevations from soil borings. If 1.75 ft is too deep, adjust the depth by providing additional storage in pipes or chambers or by enlarging the footprint of the facility.

6-1304.11E(2) Size an orifice to keep the total drain time for the facility to 24 hours for a maximum water level of 1.25 feet in the gravel storage layer (0.5 feet below the bedding layer) and a storage volume of 5,000 ft<sup>3</sup>. The average energy head ( $H_o$ ) above the centroid of the opening will be half of the maximum water level minus 2 inches (0.167 ft) for the pipe bedding.

The required discharge rate is computed from:

$$\begin{aligned} Q_u &= (V_{10} / t_d) / 3600 \\ &= (5000 / 24) / 3600 \\ &= 0.0579 \text{ cfs} \end{aligned}$$

The size of the required orifice is computed using the standard orifice equation [see § 6-1604.1A(2)]:

$$A = Q_o / C(2gH_o)^{1/2}$$

Where:

- $Q_o$  = discharge (cfs)
- $C$  = orifice coefficient, typically set at 0.6 for sharp edged orifices but may vary depending on orifice geometry
- $A$  = flow area (ft<sup>2</sup>)
- $g$  = acceleration of gravity, 32.2 ft/sec<sup>2</sup>
- $H_o$  = energy head above centroid of opening (ft)

The average energy head is:

$$\begin{aligned} H_o &= (1.25 - 0.167) / 2 \\ &= 0.512 \end{aligned}$$

The orifice area is:

$$\begin{aligned} A &= 0.0579 / 0.6(64.4 * 0.512)^{1/2} \\ &= 0.0168 \text{ ft}^2 \end{aligned}$$

The diameter of the orifice is:

$$\begin{aligned} D &= 2(A/\pi)^{0.5} \\ &= 2(0.0168/3.1416)^{0.5} \\ &= 0.15 \text{ ft} = 1.76 \text{ in} \end{aligned}$$

6-1304.11F Inflow-outflow hydrograph routings would provide a more accurate solution for these examples.

**Amend PFM 6-1300 (RETENTION AND DETENTION FACILITIES) by adding new Sections 6-1307 (Bioretention Filters and Basins), 6-1308 (Vegetated Swales), 6-1309 (Tree Box Filters), 6-1310 (Vegetated Roofs), and 6-1311 (Reforestation) to read as follows:**

## **6-1307 Bioretention Filters and Basins**

6-1307.1 Bioretention filters and basins (a.k.a. rain gardens) are landscaped areas in shallow depressions that are subject to temporary ponding of stormwater runoff. The principal components of bioretention facilities are plants that tolerate fluctuations in soil moisture and temporary ponding of water, a mulch layer, an engineered soil media, a gravel layer, and an underdrain that is connected to the storm drain system or daylighted. The soil media is highly permeable and well drained. Water quality control is provided by filtering storm water runoff through the soil media and mulch, biological and chemical reactions in the soil, mulch, and root zone, plant uptake, and infiltration into the underlying soil. The void spaces in the soil can be used to store runoff for detention or infiltration to provide reductions in the peak rate and volume of stormwater runoff. Additional infiltration capacity or storage for detention can be obtained by using a gravel layer alone or in combination with storage chambers below the soil media.

6-1307.1A Bioretention filters are designed to provide water quality control and detention of storm water runoff from small storms. Bioretention filters include underdrains that allow water that has passed through the soil media to be freely discharged.

6-1307.1B Bioretention basins are designed to provide water quality control and retention of storm water. Bioretention basins rely on infiltration into the underlying *in situ* soils to drain down between storms. Bioretention basins, as utilized in Fairfax County, generally include underdrains that are capped or have restricted outflow. This allows a bioretention basin to be converted to a bioretention filter if the infiltration capacity of the *in situ* soils is reduced over time due to clogging of the soil pores.

6-1307.1C Bioretention facilities are best suited for small drainage areas that have low sediment loads. Pre-treatment techniques that allow runoff to flow from impervious surfaces through well established lawns, naturally vegetated buffers, or specially constructed filter strips are used to remove coarse and fine grained sediments that may otherwise clog the surface of facilities. Level spreaders or stone energy dissipaters may be used to prevent concentrated flow from creating scour paths within the facility. Bioretention facilities should not be located where wooded areas would not otherwise need to be cleared as part of the site development.

6-1307.1D Trees within bioretention facilities may be used to meet the requirements of Article 13 of the Zoning Ordinance and § 12-0000 *et seq.* of the PFM.

6-1307.2 Location and Siting.

6-1307.2A In residential areas, bioretention facilities and their appurtenant structures must be located on Home Owner Association (or "common") property and may not be located on individual buildable single-family attached or detached residential lots or any part thereof for the purpose of satisfying the detention or water quality control (BMP) requirements of the Subdivision or Zoning Ordinance except as noted herein. The Director may approve the location of bioretention facilities on individual buildable single-family detached lots for subdivisions creating no more than 3 lots where it can be demonstrated that the requirement is not practical or desirable due to constraints imposed by the dimensions or topography of the property and where adequate provisions for maintenance are provided. Such approval by the Director shall be in writing and shall specify such conditions deemed necessary to ensure the effectiveness, reliability, and maintenance of the proposed facilities.

6-1307.2B Bioretention facilities may be located on individual single-family detached residential lots that are not part of a bonded subdivision to satisfy the BMP requirements of the Chesapeake Bay Preservation Ordinance for construction on the lot.

6-1307.2C Bioretention facilities that utilize infiltration may not be constructed on fill material.

6-1307.2D Bioretention facilities may not be constructed on slopes steeper than 15 percent.

6-1307.2E Setbacks. Bioretention filters shall be located a minimum of 10 feet (3 m) horizontally from building foundations preferably down gradient. Bioretention basins shall be located a minimum of 20 feet (6 m) horizontally from building foundations preferably down gradient. Bioretention facilities shall be located a minimum of 100 feet (30 m) horizontally from water supply wells. Bioretention filters shall be located a minimum of 25 feet (7.5 m) horizontally up gradient from septic fields and a minimum of 50 feet (15 m) horizontally down gradient from septic fields. Bioretention basins shall be located a minimum of 50 feet (15 m) horizontally from septic fields preferably up gradient. Bioretention facilities shall be set back a minimum of 2 feet (0.6 m) from property lines.

6-1307.2F Bioretention facilities shall not be located in the vicinity of loading docks, vehicle maintenance areas, or outdoor storage areas, where there is the potential for high concentrations of hydrocarbons, toxics, or heavy metals in stormwater runoff.

6-1307.2G The maximum drainage area to a bioretention filter shall be 2 acres (0.8 hectares). The maximum impervious area draining to a bioretention filter shall be 1 acre (0.4 hectares). The maximum drainage area to a bioretention basin shall be 1 acre (0.4 hectares). The maximum

impervious area draining to a bioretention basin shall be 0.5 acres (0.2 hectares).

6-1307.2H No minimum size is specified for bioretention facilities to allow for application on sites with limited space or topographic constraints. Bioretention facilities should be "footprinted" into the available landscape to minimize land disturbance.

6-1307.2I Bioretention facilities may be designed as on-line or off-line facilities. Off-line facilities are preferred and are mandatory when any part of the inflow to the facility is from flow in a County storm drainage easement.

6-1307.3 Maintenance.

6-1307.3A Bioretention facilities and their appurtenant structures must be privately maintained and a private maintenance agreement must be executed before the construction plan is approved. Bioretention facilities may not be located in County storm drainage easements. The above does not preclude the use of bioretention facilities by the County on County owned property.

6-1307.3B Maintenance access must be provided for all bioretention facilities not located on individual buildable single family detached lots in accordance with § 6-1306. For bioretention facilities located on individual buildable single family detached lots, maintenance access shall be considered as an integral part of the design and designated on the plan.

6-1307.3C Bioretention facilities shall be posted with permanent signs designating the area as a water quality management area. Signs shall state that the facility is a water quality management area, water may pond after a storm, and the area is not to be disturbed except for required maintenance. Signs shall be posted at approximately 150 foot (46 m) intervals along the perimeter of the bioretention area with a minimum of one sign for each facility. See Plate 81-6 (81M-6).



6-1307.4 General Design Requirements.

6-1307.4A Water Quality Volume. For facilities designed to capture and treat the first 0.5 inches (1.27 cm) of runoff, the required water quality volume is 1,815 cubic feet per acre (127 m<sup>3</sup>/ha) of impervious area. For facilities designed to capture and treat the first 1.0 inch (2.54 cm) of runoff, the required water quality volume is 3,630 cubic feet per acre (254 m<sup>3</sup>/ha) of impervious area. The water quality volume must be captured and filtered through the system.

6-1307.4B Detention. For facilities designed to provide detention, the 2-year 2-hour storm and the 10-year 2-hour storm must be routed through the facility; or the facility may be designed to infiltrate the 10-year 2-hour storm volume; or the facility may be designed to filter the 10-year 2-hour storm volume. Except where the facility is designed to filter the 10-year 2-hour storm volume, a drop inlet with a trash rack or screen shall be provided to convey stormwater in excess of the water quality volume to a gravel layer or storage chambers below the soil media.

6-1307.4C For on-line facilities, the inlet must be designed to pass the peak flow rate for the 10-year storm. For off-line facilities, a flow splitter shall be used to capture the design storm (typically the water quality volume) and pass larger flows around the facility.

6-1307.4D Pre-Treatment. Pre-treatment shall be provided at all points of concentrated inflow to facilities. Pre-treatment generally consists of a vegetated filter strip or channel and an energy dissipation device. However, space constraints (e.g. parking lot islands) may limit the ability to provide a vegetated filter strip or channel. Where space permits, vegetated filter strips or channels shall be provided. Energy dissipation devices are required for all facilities at points of concentrated inflow. Where inflow is in the form of sheet flow,

a vegetated filter strip shall be provided where space permits. Guidelines for sizing vegetated filter strips and channels are provided in Tables 6.30 and 6.31.

Table 6.30  
Pretreatment Filter Strip Sizing

Inflow Surface	Impervious				Pervious			
	35 ft (11 m)		75 ft (23 m)		75 ft (23 m)		150 ft (46 m)	
Maximum Inflow Approach Length								
Filter Strip % Slope (6% max)	≤2	≥2	≤2	≥2	≤2	≥2	≤2	≥2
Minimum Filter Strip Length Feet (meters)	10 (3)	15 (5)	20 (6)	25 (8)	10 (3)	12 (4)	15 (5)	18 (6)

Table 6.31  
Pretreatment Vegetated Channel Sizing\*

% Impervious	≤ 33%		34% - 66%		≥ 67%	
Channel Slope (4% max)	≤2%	≥ 2%	≤ 2%	≥ 2%	≤ 2%	≥ 2%
Min. Length feet (meters)	10 (3.0)	15 (4.6)	20 (6.1)	25 (7.6)	10 (3.0)	12 (3.7)

\* 1 acre (0.8 hectare) drainage area. 2 foot (0.6 m) wide channel bottom.

6-1307.4E The maximum surface storage depth from the top of the mulch layer to the elevation of the overflow weir or drop inlet shall be 1 foot (305 mm).

6-1307.4F Berms used to pond water in bioretention facilities shall be a maximum of 2.0 feet (610 mm) in height measured from the downstream toe-of-slope to the top of the berm. The width of the top of the berm shall be a minimum of 2.0 feet (610 mm). The side slopes of the berm shall be a maximum of 3:1. Berms and overflow weirs shall be sodded and pegged in accordance with the most recent edition of the Virginia Erosion and Sediment Control Handbook. Facilities with berms that are equal to or less than 2.0 feet (610 mm) in height or excavated facilities will not be subject to the requirements of § 6-1600 (Design and

Construction of Dams and Impoundments).

6-1307.4G The side slopes of the facility above ground shall be a maximum of 3:1. Where space permits, gentle side slopes (e.g. 5:1) are encouraged to blend the facility into the surrounding landscape. Side slopes of the facility excavated below ground may be as steep as the *in situ* soils will permit. All excavation must be performed in accordance with Virginia Occupational Safety and Health (VOSH) requirements. If the facility is located on problem soils (such as marine clays), a professional engineer with experience in geotechnical engineering shall specify the maximum acceptable slope.

6-1307.4H An outlet structure must be provided to convey the peak flow for the 10-year storm. The outlet structure may be a drop inlet or weir. A minimum freeboard of 6 inches (152 mm) shall be provided from the maximum elevation of the 10-year storm to the top of the facility.

6-1307.4I An emergency overflow weir shall be provided for all facilities with berms. The emergency overflow weir must have the capacity to pass the peak flow from the 100-year storm without overtopping the facility. If the facility design includes a weir in the berm to convey the peak flow for the 10-year storm, it also may be designed to function as the emergency overflow weir. The minimum weir length shall be 2 feet (610 mm).

6-1307.4J The outfall of all outlet structures, emergency overflow weirs, and underdrains must be in conformance with the adequate drainage requirements of § 6-0200 *et seq.*

6-1307.4K Underdrains shall be provided for all bioretention filters and basins except that facilities on individual single-family detached residential lots that are not part of a bonded subdivision may be constructed without underdrains if the

underdrain cannot be daylighted on the lot or connected to a storm sewer structure. If there are no underdrains, observation wells shall be installed to monitor drainage from the facility.

6-1307.4L The depth between the bottom of the facility and groundwater table or bedrock shall be a minimum of 4 feet (1220 mm) for bioretention basins and a minimum of 2 feet (610 mm) for bioretention filters as determined by field run soil borings.

6-1307.4M For facilities designed to provide infiltration, the underdrain shall be restricted as necessary so that the design infiltration rate plus the underdrain outflow rate equals the design draw down rate. The restriction shall be achieved by using an end cap with a hole to act as an orifice or a valve fitted onto the end of the underdrain. Alternatively a flow control satisfactory to the Director may be provided within the overflow structure. See § 6-1604.1A(2) for orifice calculations. The minimum diameter of any orifice shall be 0.5 inch (13 mm). Facilities shall be designed to dewater completely within 48 hours. If the facility can drain in the required time without any outflow through the underdrain, the end cap may be provided without a hole.

6-1307.4N The minimum soil media depth shall be 2.5 feet (762 mm). If large trees and shrubs are to be installed, soil depths shall be increased to a minimum of 4 feet (1219 mm). The bottom of the soil layer must be a minimum of 4 inches (102 mm) below the root ball of plants to be installed. A layer of 2-3 inches (51-76 mm) of mulch shall be placed on top of the soil media.

6-1307.4O For facilities utilizing infiltration, a soils analysis shall be prepared and infiltration tests conducted by a licensed professional engineer with experience in geotechnical engineering and soil evaluation, a certified professional soil scientist, or a certified professional geologist. Recommended guidelines for

performing the field tests and soils analysis are available from the Department of Public Works and Environmental Services. A minimum field measured infiltration rate of 0.52 inches per hour (13.2 mm/hr) shall be required for infiltration. The design infiltration rate shall be half of the field measured rate.

6-1307.4P Variations of the bioretention filter and basin designs in Plates 82-6, 83-6, 84-6, 85-6, and 86-6 (82M-6, 83M-6, 84M-6, 85M-6, & 86M-6) may be approved by the Director provided the facility meets all of the requirements in § 6-1307 *et seq.*

#### 6-1307.5 Filter Bed Design.

6-1307.5A The required surface area of the filter is based on the volume of water to be treated and the available storage in the ponding area computed as follows:

$$A_f = WQ_v/h_f$$

Where:

- $A_f$  = area of filter (ft<sup>2</sup>)
- $WQ_v$  = water quality volume (ft<sup>3</sup>)
- $h_f$  = maximum ponding depth (ft)

6-1307.5B The drain time through the filter is based on the volume of water to be treated and the hydraulic properties of the soil media in accordance with Darcy's law computed as follows:

$$t_f = (WQ_v)(d_f)/[(k_f/12)(0.5h_f+d_f)A_f]$$

Where:

- $t_f$  = drain time through filter (hrs)
- $WQ_v$  = water quality volume (ft<sup>3</sup>)
- $d_f$  = depth of filter (ft)
- $k_f$  = coefficient of permeability (in/hr)
- $h_f$  = maximum ponding depth (ft)
- $A_f$  = area of filter (ft<sup>2</sup>)

6-1307.5C A coefficient of permeability of 1.5 in/hr (38.1 mm/hr) for the soil media shall be used for sizing calculations. The water quality volume must drain through

the filter section in 24 hours. In determining the drain time through the filter, assume that the rainfall event has ended and the ponding depth is at the maximum elevation prior to the initiation of drawdown.

#### 6-1307.6 Gravel Layer/Storage Chamber Design.

6-1307.6A Storage Volume. Storage for detention or infiltration may be provided by a layer of gravel or gravel in combination with storage chambers beneath the soil media. Water flows into the storage layer either through an inlet structure or through the soil media layer. Water flows out of the storage layer either by infiltration into the underlying *in situ* soils or through a restricted underdrain. The design objectives are to infiltrate as much of the water as possible, to provide sufficient storage so that water can drain freely through the filter without being backed-up, to assure that there is complete drain down of the facility between storms, and to meet the physical constraints of the site.

6-1307.6A(1) For facilities designed to infiltrate the water quality volume, the amount of storage required is based on the flow rate through the filter minus the infiltration rate into the underlying *in situ* soils and the outflow through the underdrain during the filling period. The required storage volume is computed as follows:

$$V_s = WQ_v - [(k_s)(A_s)(t_f)/12] - [3600(Q_u)(t_f)]$$

Where:

- $V_s$  = volume of storage (ft<sup>3</sup>)
- $WQ_v$  = water quality volume (ft<sup>3</sup>)
- $k_s$  = soil infiltration rate (in/hr)
- $A_s$  = area of soil bed (ft<sup>2</sup>)
- $t_f$  = drain time through filter (hrs)
- $Q_u$  = outflow through underdrain (cfs)

6-1307.6A(2) For facilities designed to provide detention in addition to filtering the water quality volume, the water

quality volume is replaced in the above equation by the total storm runoff volume for the design storm ( $V_{ds}$ ). The required storage volume is computed as follows:

$$V_s = V_{ds} - [(k_s)(A_s)(t_f)/12] - [3600(Q_u)(t_f)]$$

6-1307.6B Storage Depth. Typically, the area of the soil bed will be known (approximately equal to the area of filter bed for larger facilities) and the depth of the gravel layer will be computed from the required storage and the porosity of the gravel as follows:

$$d_g = V_s / [(n_g)(A_s)]$$

Where:

- $d_g$  = depth of gravel layer (ft)
- $V_s$  = volume of storage (ft<sup>3</sup>)
- $n_g$  = porosity of gravel
- $A_s$  = area of soil bed (ft<sup>2</sup>)

6-1307.6C After determining the depth of the gravel layer, check the invert elevation against the elevation of the water table and bedrock. Also check that the facility can drain to the intended outfall.

6-1307.6D Facility Drain Time. The final step in the design of the gravel layer is to compute the time that it takes the facility to drain. The facility must drain completely within 48 hours after the water quality volume has been captured by the filter section. The drain time is computed as follows:

$$t_d = V_s / [(k_s)(A_s)/12 + 3600(Q_u)] + t_f$$

Where:

- $t_d$  = total drain time for facility (hrs)
- $V_s$  = volume of storage (ft<sup>3</sup>)
- $k_s$  = soil infiltration rate (in/hr)
- $A_s$  = area of soil bed (ft<sup>2</sup>)
- $Q_u$  = outflow through underdrain (cfs)
- $t_f$  = drain time through filter (hrs)

6-1307.6E For facilities designed as bioretention filters with unrestricted

underdrains, computation of the storage volume, storage depth, and facility drain time are not necessary. However, it is still necessary to check the invert elevation of the gravel layer against the elevation of the water table, bedrock, and the intended outfall.

6-1307.6F For facilities designed as bioretention basins, the infiltration rate into the underlying *in situ* soils typically will be less than the flow rate through the filter and the outflow through the underdrain will be restricted or absent such that some storage will be required. In performing computations of the storage volume, storage depth, and facility drain time, initially assume that the underdrain is capped and there is no outflow through the underdrain. If the allowable depth of the storage layer based on the elevation of the groundwater table or bedrock is insufficient to provide the necessary storage volume, storage may be increased by increasing the area of the filter and soil bed or by incorporating storage chambers. Alternatively, the underdrain may be provided with an orifice to decrease the amount of storage needed. If the total drain time of the facility is in excess of 48 hours, it will be necessary to provide an orifice and recompute the total drain time through the facility. Outflow through the orifice may not exceed the pre-development peak flow rates for the 2-year and 10-year storms.

6-1307.6G A porosity of 0.40 for VDOT #57 stone shall be used for volume calculations.

6-1307.7 Underdrains. Underdrains shall consist of pipe  $\geq$  4 inch (102 mm) in diameter placed in a layer of washed VDOT #57 stone. There shall be a minimum of 2 inches (51 mm) of gravel above and below the pipe. Laterals shall be a minimum of 4-6 inches (102-152 mm) in diameter. Main collector lines and manifolds shall be a minimum of 6-8 inches (152-203 mm) in diameter. Underdrains shall be laid at a minimum slope of 0.5%. Underdrains shall extend

to within 10 feet (3 m) of the boundary of the facility and have a maximum internal spacing of 20 feet (6 m) on center. Underdrains shall be separated from the soil media by geotextile fabric or a 2-3 inch (51-76 mm) layer of washed VDOT #8 stone or 1/8-3/8 inch (3.2-9.5 mm) pea gravel. Underdrains not terminating in an observation well/clean-out shall be capped. The portion of underdrain piping beneath the planting soil bed must be perforated. All remaining underdrain piping, including cleanouts, must be nonperforated. All stone shall be washed with less than 1% passing a #200 sieve.

6-1307.8 Observation Wells and Cleanouts. There shall be a minimum of one observation well or cleanout per 1,000 square feet (93 m<sup>2</sup>) of surface area. Observation wells and cleanouts shall be a minimum of 6 inches (152 mm) in diameter with a screw, or flange type cap to discourage vandalism and tampering extending above the BMP water surface elevation. Cleanouts shall be provided at the end of all pipe runs. Cleanouts and observation wells shall be solid pipe except for the portion below the planting soil bed which must be perforated. Observation wells that are not connected to underdrain piping shall be anchored to a footplate at the bottom of the facility.

#### 6-1307.9 Materials Specifications.

6-1307.9A The bioretention soil media shall be composed of a mixture of 60-75% washed sand, 5-15% organic compost meeting the requirements of Table 6.32, and 10-35% topsoil. Topsoil shall be a sandy loam, loamy sand, silt loam or loam per USDA textural classification. The textural class of the topsoil shall be verified by a laboratory analysis. Topsoil shall be of uniform composition, containing no more than 8% clay, free of stones, stumps, brush, roots, or similar objects larger than 2 inches. Topsoil shall be free of Bermuda Grass, Quackgrass, Johnson Grass, Mugwort, Nutsedge,

Poison Ivy, Canadian Thistle, Tearthumb, or other noxious weeds. Sand shall meet AASHTO M-6, ASTM C-33, or VDOT Section 202 Grade "A" Fine Aggregate specifications. Sand shall be clean and free of deleterious materials. The final soil mixture shall not contain any material or substance that may be harmful to plant growth, or a hindrance to plant growth or maintenance. The final soil mixture shall meet the requirements in Table 6.33. Each bioretention area shall have a minimum of one soil test performed on the final soil mixture. Test results and materials certifications shall be submitted to DPWES prior to bond release.

6-1307.9B Mulch shall be double shredded aged hardwood bark with a particle size greater than 0.5 inches (1.27 cm). Mulch shall be well aged, uniform in color, and free of salts, harmful chemicals, and extraneous material including soil, stones, and plant material. Well aged mulch is mulch that has been stockpiled or stored for 6-12 months.

6-1307.9C Underdrains shall be PVC pipe conforming to the requirements of ASTM F758, Type PS 28 or ASTM F949; HDPE pipe conforming to the requirements AASHTO M252 or M 294, Type S; or approved equivalent pipe. Underdrains shall be perforated with 4 rows of 3/8 inch (9.5 mm) holes with a hole spacing of  $3.25 \pm 0.25$  inches ( $82.5 \pm 6.4$  mm) or a combination of hole size and spacing that provides a minimum inlet area  $\geq 1.76$  square inches per linear foot (37.2 cm<sup>2</sup>/m) of pipe or be perforated with slots 0.125 inches (3.2 mm) in width that provides a minimum inlet area  $\geq 1.5$  square inches per linear foot (31.8 cm<sup>2</sup>/m) of pipe.

6-1307.9D Filter fabric. Filter fabric shall be a needled, non-woven, polypropylene geotextile meeting the requirements listed in Table 6.34. Heat-set or heat-calendared fabrics are not permitted.

Table 6.32 Compost Specifications

pH	6.0-8.0
Soluble Salts (electrical conductivity)	<5 dS/m (mmhos/cm)
Nutrient Content (dry weight basis)	Nitrogen – 1% or above Phosphorus – 1% or above Potassium – 1% or above
Organic Matter Content (dry weight basis)	50-60%
Moisture Content (wet weight basis)	40-50%
Particle Size (aggregate size)	Pass through a 1/2 inch screen or smaller
Maturity Indicator (percentage of control)	>80% of control
Stability (CO <sub>2</sub> evolution)	0-4 mg CO <sub>2</sub> C per g OM per day
Trace Elements/Heavy Metals	Meet U.S. EPA Class A standard, 40 CFR § 503.13. Tables 1 and 3
Pathogens	Meet U.S. EPA Class A standard, 40 CFR § 503.32(a)

Table 6.33 Soil Media Specifications

pH	5.5-6.5
Total Organic Matter by Loss on Ignition (ASTM F1647, Method A)	≥ 1.5% (dry weight)
Soluble Salts	≤ 500 ppm

6-1307.10A Bioretention planting plans and specifications shall be prepared by a certified landscape architect, horticulturist, or other qualified individual who has knowledge of the environmental tolerance, ecological functions, and ecological impacts of plant species. Planting plans shall be prepared in accordance with the requirements of § 12-0700.

Table 6.34 Filter Fabric Specifications

Grab Tensile Strength (ASTM D4632)	≥ 120 lbs (534 N)
Mullen Burst Strength (ASTM D3786)	≥ 225 lbs/in <sup>2</sup> (1550 kPa)
UV Resistance (ASTM D4355)	70% strength after 500 hours
Flow Rate (ASTM D4491)	≥ 125 gal/min/ft <sup>2</sup> (5093 l/min/m <sup>2</sup> )
Apparent Opening Size (AOS) (ASTM D4751)	US #70 or #80 sieve (0.212 or 0.180 mm)

6-1307.10B Depending on the bioretention planting plan type and application as detailed in § 6-1307.10G, a mixture of trees, shrubs, and perennial herbaceous plants with a high density of fibrous roots is required. Selected plants must be able to tolerate highly variable moisture conditions, generally dry with brief periods of inundation. Depending on site conditions, selected plants also must be able to tolerate exposure to wind and sun, as well as salt and toxins in runoff from roads, parking lots, and driveways. The use of native plant species is preferred. The acceptability of proposed plant materials will be determined by the Director. Guidance on the use and selection of plants for bioretention

6-1307.10 Bioretention Planting Plans.

facilities is available from the Urban Forest Management Division.

6-1307.10C All plants shall conform to the latest version of American Standard for Nursery Stock published by the American Nursery and Landscape Association (ANSI Z60.1) for quality and sizing. Trees and shrubs shall be nursery grown unless otherwise approved and shall be healthy and vigorous, free from defects, decay, disfiguring roots, sun-scald, injuries, abrasions, diseases, insects pests, and all forms of infestations or objectionable disfigurements as determined by the Director.

6-1307.10D Trees shall be a minimum of 1 inch (25.4 mm) caliper. Shrubs shall be a minimum of 2 gallon (7.57 L) container size and herbaceous plants shall be a minimum of 6 inch (152 mm) diameter container size. Variations in size may be approved by the Director, based on the requirements of the specific plants listed in the schedule.

6-1307.10E The planting plan shall provide for plant community diversity and should consider aesthetics from plant form, color, and texture year-round. The bioretention facility design and selection of plant material shall serve to visually link the facility into the surrounding landscape. If trees and shrubs are part of the design, woody plant species shall not be placed directly within the inflow section of the bioretention facility.

6-1307.10F All plantings must be well established prior to release of the conservation deposit. Nursery stock trees and shrubs required by the approved plan shall be viable (healthy and capable of developing a trunk and branch structure typical for their species) at the time the conservation deposit is released.

6-1307.10G Bioretention Planting Plan Types and Applications.

6-1307.10G(1) Wooded planting plans. Wooded bioretention facilities are

appropriate where the facility is located at wooded edges, in the rear of residential lots, or where a wooded buffer is required. Design guidelines include:

6-1307.10G(1)(a) A density of ten (10) trees per 1,000 square feet (93 m<sup>2</sup>) of basin shall be used.

6-1307.10G(1)(b) A minimum of three species of trees and three species of shrubs shall be planted, with trees located on the perimeter to maximize shading of the bioretention area;

6-1307.10G(1)(c) Of the three species of trees, at a minimum one shall be a mid or understory species; 30-50% of the total quantity of trees planted shall be mid or understory trees;

6-1307.10G(1)(d) Two to three shrubs shall be planted for each tree (2:1 to 3:1 ratio of shrubs to trees);

6-1307.10G(1)(e) At least 3 species of perennial herbaceous ground cover shall be planted;

6-1307.10G(1)(f) Where the basin is planted at the specified density, interior and peripheral parking lot landscaping and tree cover credit will be granted if planting conforms to the requirements of Article 13 of the Zoning Ordinance and § 12-0702 and § 12-0703;

6-1307.10G(1)(g) Trees planted in wooded bioretention facilities may also fulfill the requirements of transitional screening if the planting conforms to the provisions of Article 13-300 of the Zoning Ordinance.

6-1307.10G(2) Ornamental garden planting plans. Ornamental garden bioretention facilities are appropriate on commercial sites, as a focal point within residential developments or located in the front yard of an individual residential lot. Design guidelines include:

6-1307.10G(2)(a) The facility should be considered as a mass planting bed with plants that have ornamental characteristics linking it to the surrounding landscape;

6-1307.10G(2)(b) The facility should contain a variety of plant species which will add interest to the facility with each changing season;

6-1307.10G(2)(c) A mixture of trees, shrubs and perennial herbaceous groundcover at an approximate ratio of 10% trees, 20% shrubs and 70% perennials shall be planted;

6-1307.10G(2)(d) When the size or location of the facility precludes the use of large shade trees, use of small ornamental trees shall be considered. Alternatively, a mixture of shrubs and perennials at an approximate ratio of 40% shrubs, 60% perennials may be used;

6-1307.10G(2)(e) Spacing of plant material is species specific and will be subject to review and approval of the Director. In general the facility shall be planted at a density that the vegetation will cover 80-90% of the facility after the second growing season.

6-1307.10G(3) Meadow garden planting plans. Meadow garden bioretention facilities lack woody material and are appropriate for small facilities, either on commercial or residential sites. Design guidelines include:

6-1307.10G(3)(a) Plant material shall consist of a variety of grasses and wildflowers. Other groundcovers, rushes and sedges may be part of the mixture as well;

6-1307.10G(3)(b) Species of different heights, texture, as well as flowering succession shall be selected;

6-1307.10G(3)(c) Spacing of plant material is species specific and will be subject to review and approval of the

Director. In general the facility shall be planted at a density that the perennial herbaceous vegetation will cover 80-90% of the facility after the second growing season.

#### 6-1307.11 Construction Specifications.

6-1307.11A The owner shall provide for inspection during construction of the facility by a licensed design professional (In accordance with standard practice, the actual inspections may be performed by an individual under responsible charge of the licensed professional). The licensed professional shall certify that the facility was constructed in accordance with the approved plans. The licensed professional's certification along with any material delivery tickets and certifications from the material suppliers and results of the tests and inspections required under § 6-1307.9A, § 6-1307.11D, and § 6-1307.11K shall be submitted to the County prior to bond release. For projects requiring as-built plans, the required certification and supporting documents shall be submitted with or incorporated in the as-built plans. For projects that do not require as-built plans, the required certification and supporting documents shall be submitted with the RUP or non-RUP request.

6-1307.11B Bioretention facilities shall be constructed after the drainage area to the facility is completely stabilized. Erosion and sediment controls for construction of the facility shall be installed as specified in the erosion and sediment control plan.

6-1307.11C The components of the soil media shall be thoroughly mixed until a homogeneous mixture is obtained. It is preferable that the components of the soil media be mixed at a batch facility prior to delivery to the site. The soil media shall be moistened, as necessary, to prevent separation during installation.

6-1307.11D The soil media shall be tested for pH, organic matter, and soluble salts prior to installation. If the results of the



tests indicate that the required specifications are not met, the soil represented by such tests shall be amended or corrected as required and retested until the soil meets the required specifications. If the pH is low, it may be raised by adding lime. If the pH is too high, it may be lowered by adding iron sulfate plus sulfur.

6-1307.11E For bioretention basins, the floor of the facility shall be scarified or tilled to reduce soil compaction and raked to level it before the filter fabric, stone, and soil media are placed.

6-1307.11F The soil media may be placed by mechanical methods with minimal compaction in order to maintain the porosity of the media. Spreading shall be by hand. The soil media shall be placed in 8-12 inch (203-305 mm) lifts with no machinery allowed over the soil media during or after construction. The soil media should be overfilled above the proposed surface elevation as needed to allow for natural settlement. Lifts may be lightly watered to encourage settlement. After the final lift is placed, the soil media shall be raked to level it, saturated, and allowed to settle for at least one week prior to installation of plant materials.

6-1307.11G Fill for the berm and overflow weir shall consist of clean material free of organic matter, rubbish, frozen soil, snow, ice, particles with sizes larger than 3 inches (76 mm), or other deleterious material. Fill shall be placed in 8-12 inch (203-305 mm) lifts and compacted to prevent settlement. Compaction equipment shall not be allowed within the facility on the soil bed. The top of the berm and the invert of the overflow weir shall be constructed level at the design elevation.

6-1307.11H Plant material shall be installed per § 12-0805.

6-1307.11I Planting shall take place after construction is completed and during the following periods: March 15 through June

15 and September 15 through November 15 unless otherwise approved by the Director.

6-1307.11J All areas surrounding the facility that are graded or denuded during construction of the facility and are to be planted with turf grass shall be sodded.

6-1307.11K The facility shall be inspected at 12-24 and 36-48 hours after a significant rainfall [0.5-1.0 inch (1.27-2.54 cm)] or artificial flooding to determine that the facility is draining properly. Results of the inspection shall be provided to DPWES prior to bond release.

6-1307.12 Plan Submission Requirements.

6-1307.12A Plan view(s) with topography at a contour interval of no more than one foot and spot elevations throughout the facility showing all hydraulic structures including underdrains.

6-1307.12B Cross section(s) of the facility showing the following: elevations and dimensions of berm, inlet, outlet, underdrain, soil media, underlying gravel layer, storage chambers, filter fabric, groundwater table, and bedrock.

6-1307.12C Plant schedule and planting plan specifying species, quantity of each species, stock size, type of root stock to be installed and amount of tree cover claimed for each tree species or spacing of shrubs and perennials within facility. Planting plan shall be in conformance with § 12-0700.

6-1307.12D Sizing computations for the facility including volume of storage and surface area of facility required and provided.

6-1307.12E Hydrologic calculations for the facility.

6-1307.12F Design calculations and specifications for all hydraulic structures

including inlet structures, overflow weirs, and underdrain piping.

6-1307.12G Infiltration calculations as appropriate.

6-1307.12H Soils analysis and testing results for facilities that utilize infiltration. Elevation of groundwater table and/or bedrock.

6-1307.12I A discussion of the outfalls from the facility is to be included in the outfall narrative.

6-1307.12J Construction and materials specifications.

6-1307.13 Bioretention Design Example:

6-1307.13A Given:

Drainage area to the facility = 20,000 ft<sup>2</sup>;

Impervious area (A<sub>i</sub>) = 15,000 ft<sup>2</sup>;

Depth of filter (d<sub>f</sub>) = 2.5 ft

Maximum ponding depth (h<sub>f</sub>) = 1.0 ft

Coefficient of permeability of filter bed (k<sub>f</sub>) = 1.5 in/hr

Design infiltration rate of *in situ* soils (k<sub>s</sub>) = 0.35 in/hr (one-half of field measured rate of 0.7 in/hr);

Porosity of gravel (n<sub>g</sub>) = 0.40

6-1307.13B Determine the required area of the filter bed (A<sub>f</sub>) for a water quality volume (WQ<sub>v</sub>) of 1.0 inch per impervious acre (3,630 ft<sup>3</sup>).

6-1307.13B(1) The water quality volume is:

$$\begin{aligned} WQ_v &= 3,630 \text{ ft}^3 \left( 15,000 \text{ ft}^2 / 43,560 \text{ ft}^2 \right) \\ &= 1,250 \text{ ft}^3 \end{aligned}$$

6-1307.13B(2) The area of the filter bed is:

$$\begin{aligned} A_f &= WQ_v / h_f \\ &= 1250 / 1.0 = 1,250 \text{ ft}^2 \end{aligned}$$

6-1307.13B(3) Compute the drain time through the filter for a filter area of 1,250 ft<sup>2</sup> (Must be less than 24 hrs.).

$$\begin{aligned} t_f &= (WQ_v)(d_f) / [(k_f / 12)(0.5h_f + d_f)A_f] \\ &= (1250)(2.5) / \\ &\quad [(1.5/12)(0.5(1.0) + 2.5)1250] \\ &= 6.67 \text{ hrs} \leq 24 \text{ hrs OK} \end{aligned}$$

If the facility is to be designed as a bioretention filter, the sizing computations are complete and a standard underdrain will be installed with no flow restriction.

6-1307.13C Determine the required storage volume (V<sub>s</sub>) and depth (d<sub>g</sub>) of the of the gravel layer to provide for infiltration of the entire water quality volume (WQ<sub>v</sub>) [1,250 ft<sup>3</sup>]. The design infiltration rate (k<sub>s</sub>) is equal to half of the field measured rate of 0.7 in/hr. Assume that the area of the soil bed (A<sub>s</sub>) is equal to the area of the filter (A<sub>f</sub>). Ignore any additional storage that may be provided by the underdrain pipes and assume that there is no outflow (Q<sub>u</sub>) through the underdrain.

6-1307.13C(1) The required storage volume is:

$$\begin{aligned} V_s &= WQ_v - [(k_s)(A_s)(t_f)/12] - \\ &\quad [3600(Q_u)(t_f)] \\ &= 1250 - [0.35(1250)(6.67)/12] - 0 \\ &= 1,006.8 \text{ ft}^3 \end{aligned}$$

Use: V<sub>s</sub> = 1,007 ft<sup>3</sup>

6-1307.13C(2) Compute the depth of the gravel storage area for a soil bed area of 1,250 ft<sup>2</sup> and a storage volume of 1,007 ft<sup>3</sup>.

$$\begin{aligned} d_g &= V_s / [(n_g)(A_s)] \\ &= 1007 / [(0.40)(1250)] \\ &= 2.01 \text{ ft} \end{aligned}$$

Use d<sub>g</sub> = 2.0 ft

Check the depth between the bottom of the gravel storage area and the groundwater table and bedrock elevations from soil borings.

6-1307.13C(3) Compute the total drain time for the facility for a filter area and

soil bed area of 1,250 ft<sup>2</sup>, a storage volume of 1,007 ft<sup>3</sup>, and a drain time through the filter of 6.67 hrs (Must be less than 48 hrs.).

$$t_d = V_s / [(k_s)(A_s) / 12 + 3600(Q_u)] + t_f$$

$$= 1007 / [(0.35)(1250) / 12 + 0] + 6.67$$

$$= 34.3 \text{ hrs} \leq 48 \text{ hrs OK}$$

If the soil infiltration rate is less than the coefficient of permeability of the filter and there is no outflow through the underdrain, the total drain time for the facility can also be computed from:

$$t_d = WQ_v / [(k_s)(A_s) / 12]$$

$$= 1250 / [(0.35)(1250) / 12]$$

$$= 34.3 \text{ hrs}$$

6-1307.13D Redesign the facility to provide detention of the 10-year 2-hour storm in addition to water quality control and to maximize infiltration. Note that a drop inlet will be required to deliver the storm volume in excess of the 1,250 ft<sup>3</sup> captured by the filter section to the gravel storage layer. The 10-year 2-hour storm volume is 3 inches (10,890 ft<sup>3</sup>) per impervious acre. Assume the gravel storage layer fills in 2 hours and that there is no outflow through the orifice during the filling period.

6-1307.13D(1) The 10-year 2-hour storm volume is:

$$V_{10} = 10,890 \text{ ft}^3 \text{ (15,000 ft}^2 \text{ / 43,560 ft}^2\text{)}$$

$$= 3,750 \text{ ft}^3$$

6-1307.13D(2) Determine the required storage volume (V<sub>s</sub>).

$$V_s = V_{10} - [(k_s)(A_s)(t_f) / 12] - [3600(Q_u)(t_f)]$$

$$= 3750 - [0.35(1250)(6.67) / 12] - 0$$

$$= 3,506.8 \text{ ft}^2$$

6-1307.13D(3) Compute the depth of the gravel storage area for a soil bed area of 1,250 ft<sup>2</sup> and a storage volume of 2,963 ft<sup>3</sup>.

$$d_g = V_s / [(n_g)(A_s)]$$

$$= 3507 / [(0.40)(1250)]$$

$$= 7.01 \text{ ft}$$

Check the depth between the bottom of the gravel storage area and the groundwater table and bedrock elevations from soil borings. If 7.01 ft is too deep, adjust the depth by providing additional storage in pipes or chambers or by enlarging the footprint of the facility.

6-1307.13D(4) Size an orifice for the underdrain system to keep the total drain time for the facility to less than 48 hrs.

The required discharge rate is computed from:

$$Q_u = [(V_{10} / t_d) - (k_s \times A_s) / 12] / 3600$$

$$= [(3750 / 48) - (0.35 \times 1250) / 12] / 3600$$

$$= 0.0116 \text{ cfs}$$

The size of the required orifice is computed using the standard orifice equation [see § 6-1604.1A(2)]:

$$Q_o = CA(2gH_o)^{1/2}$$

Where:

- Q<sub>o</sub> = discharge (cfs)
- C = orifice coefficient, typically set at 0.6 for sharp edged orifices but may vary depending on orifice geometry
- A = flow area (ft<sup>2</sup>)
- g = acceleration of gravity, 32.2 ft/sec<sup>2</sup>
- H<sub>o</sub> = energy head above centroid of opening (ft)

There are two unknowns in this equation, the orifice area and the energy head. One approach is to assume an orifice size. Based on the assumed orifice size, the average energy head required for the design flow rate can be computed and compared to the depth of the gravel storage area. If the energy head is less than half the depth of the gravel storage area we can safely assume that the facility will drain in 48 hours.

Try the minimum size orifice (0.5 inch diameter; 0.001364 ft<sup>2</sup>).

$$H_o = [(Q_o/CA)^2 ]/2g$$

$$H_o = [(0.0116/0.6*0.001364)^2]/64.4 \\ = 3.12 \text{ ft} \geq 0.5 \times 7.01 \text{ ft } \underline{\text{not OK}}$$

Try a 5/8 inch diameter orifice (0.002131 ft<sup>2</sup>).

$$H_o = [(Q_o/CA)^2 ]/2g$$

$$H_o = [(0.0116/0.6*0.002131)^2]/64.4 \\ = 1.28 \text{ ft} \leq 0.5 \times 7.01 \text{ ft OK}$$

6-1307.13E Inflow-outflow hydrograph routings would provide a more accurate solution for these examples.

### 6-1308 Vegetated Swales

6-1308.1 Vegetated swales are open, shallow channels with vegetation covering the side slopes and bottom that collect and slowly convey stormwater runoff to downstream discharge points. The principal components of vegetated swales are a dense covering of plants, with a deep root system to resist scouring, that tolerate fluctuations in soil moisture and temporary ponding of water, check dams to pond water along the length of the swale, an engineered soil media, and an underdrain in a gravel layer that is connected to the storm drain system or daylighted. The soil media is highly permeable and well drained. Water quality control is provided by sedimentation, filtering of stormwater runoff through the vegetation and soil media, biological and chemical reactions in the soil and root zone, plant uptake, and infiltration into the underlying soils. Reductions in the peak rate of runoff are achieved due to increases in the time of concentration compared to conventional conveyance systems and the temporary storage provided by the check dams and the void spaces in the soil and underdrain gravel. Infiltration into the underlying soils may provide some volume reduction. Vegetated swales are best suited for small drainage areas that have low sediment loads.

### 6-1308.2 Location and Siting.

6-1308.2A In residential areas, vegetated swales and their appurtenant structures must be located on Home Owner Association (or "common") property and may not be located on individual buildable single-family attached or detached residential lots or any part thereof for the purpose of satisfying the detention or water quality control (BMP) requirements of the Subdivision or Zoning Ordinance except as noted herein. The Director may approve the location of vegetated swales on individual buildable single-family detached lots for subdivisions creating no more than 3 lots where it can be demonstrated that the requirement is not practical or desirable due to constraints imposed by the dimensions or topography of the property and where adequate provisions for maintenance are provided. Such approval by the Director shall be in writing and shall specify such conditions deemed necessary to ensure the effectiveness, reliability, and maintenance of the proposed facilities.

6-1308.2B Vegetated swales may be located on individual single-family detached residential lots that are not part of a bonded subdivision to satisfy the BMP requirements of the Chesapeake Bay Preservation Ordinance for construction on the lot.

6-1308.2C Vegetated swales may not be located in the VDOT right-of-way without specific approval from VDOT.

6-1308.2D Setbacks. Vegetated swales shall be located a minimum of 10 feet (3 m) horizontally from building foundations preferably downgradient. Vegetated swales shall be located a minimum of 100 feet (30 m) horizontally from water supply wells. Vegetated swales shall be located a minimum of 25 feet (7.5 m) horizontally up gradient from septic fields and 50 feet (15 m) horizontally down gradient from septic fields. Vegetated swales shall be

set back a minimum of 2 feet (0.6 m) from property lines.

6-1308.2E Vegetated swales shall not be located in the vicinity of loading docks, vehicle maintenance areas, or outdoor storage areas, where there is the potential for high concentrations of hydrocarbons, toxics, or heavy metals in stormwater runoff.

6-1308.2F In order to maintain healthy growth, swales vegetated solely with grass shall be located so that they receive a minimum of 6 hours of sunlight daily during the summer months throughout the entire length of the swale.

6-1308.2G The maximum drainage area to a vegetated swale shall be 2 acres (0.8 hectares). The maximum impervious area draining to a vegetated swale shall be 1 acre (0.4 hectares).

6-1308.2H Vegetated swales typically are designed as on-line conveyance systems but may be used off-line as pre-treatment for other types of BMPs.

6-1308.3 Maintenance.

6-1308.3A Vegetated swales and their appurtenant structures must be privately maintained and a private maintenance agreement must be executed before the construction plan is approved. Vegetated swales may not be located in County storm drainage easements. The above does not preclude the use of vegetated swales by the County on County owned property.

6-1308.3B Maintenance access must be provided for all vegetated swales not located on individual buildable single family detached lots in accordance with § 6-1306 except that the access way may have a grass surface rather than an all weather surface. For vegetated swales located on individual buildable single family detached lots, maintenance access shall be considered as an integral part of the design and designated on the plan.

6-1308.3C Vegetated swales shall be posted with permanent signs designating the area as a water quality management area. Signs for vegetated swales with check dams (swales designed to capture and treat the water quality volume) shall state that the facility is a water quality management area, water may pond after a storm, and the area is not to be disturbed except for required maintenance. Signs for vegetated swales (grass) without check dams shall state that the facility is a water quality management area and that the grass is to be maintained at a 4-8 inch (10-20 cm) height. Signs shall be posted at approximately 150 foot (46 m) intervals along the length of the vegetated swale on alternating sides with a minimum of one sign for each swale. See Plate 81-6 (81M-6).

6-1308.4 General Design Requirements.

6-1308.4A Vegetated swales may be designed to capture and treat the water quality volume using check dams or as simple conveyance systems without check dams. Swales designed as simple conveyance systems are not as effective in reducing pollutants as swales designed to capture and treat the water quality volume. Swales designed as simple conveyance systems are more commonly vegetated with grass. Swales designed to capture and treat the water quality volume are more commonly vegetated similarly to bioretention facilities.

6-1308.4B Pre-treatment. Bioretention soil media is not cohesive and must be protected from erosive forces. Energy dissipation devices with level spreaders shall be provided at all points of concentrated inflow to vegetated swales.

6-1308.4C The hydraulic capacity of vegetated swales shall be calculated using the procedures found in §6-1000 of the PFM. For grass swales, an "n" value of 0.2 shall be used for flow depths up to 4 inches (102 mm) decreasing to 0.03 at a

depth of 12 inches (305 mm). For swales vegetated with a combination of native grasses, other types of ground covers, and shrubs an "n" value of 0.15 shall be used.

6-1308.4D Vegetated swales shall be designed to convey the 10-year peak discharge within the channel and with a minimum freeboard of 6 inches (152 mm) at all check dams. The maximum velocity for the 2-year peak discharge shall be 3 feet (0.91 m) per second.

6-1308.4E Swales shall be trapezoidal in shape to provide an even distribution of flow along the channel bottom. The bottom width of swales shall be 2-10 feet (0.6-3.0 m). Side slopes shall be no steeper than 3:1. Swales may vary in width along their length to conform to site topography and design goals.

6-1308.4F The longitudinal slope of vegetated swales shall be 1-5 percent.

6-1308.4G Underdrains shall be provided for all vegetated swales.

6-1308.4H The depth between the bottom of the gravel underdrain and the groundwater table or bedrock shall be a minimum of 2 feet (610 mm) as determined by field run soil borings.

6-1308.4I The minimum soil media depth shall be 2.0 feet (610 mm) for vegetated swales designed to capture and treat the water quality volume (swales with check dams). If trees and large shrubs are to be installed, soil depths shall be increased to a minimum of 4 feet (1219 mm). The bottom of the soil layer must be a minimum of 4 inches (102 mm) below the root ball of plants to be installed. A layer of 2-3 inches (51-76 mm) of mulch shall be placed on top of the soil media in areas not planted with vegetation.

Biodegradable erosion control netting conforming to Standard and Specification 3.36 of the Virginia Erosion and Sediment Control Handbook, 3<sup>rd</sup> edition, 1992, shall be used to retain the mulch and surface

soils until the surface of the swale is established.

6-1308.4J The minimum soil media depth shall be 1.0 feet (305 mm) for vegetated swales (grass) designed to filter the water quality design flow (swales without check dams).

6-1308.4K The outfall of all vegetated swales and underdrains must be in conformance with the adequate drainage requirements of § 6-0200 *et seq.*

6-1308.4L Variations of the vegetated swale designs in Plates 87-6, 88-6, and 89-6 (87M-6, 88M-6, and 89M-6) may be approved by the Director provided the facility meets all of the requirements in § 6-1308 *et seq.*

6-1308.5 Water Quality Volume Based Design.

6-1308.5A For facilities designed to capture and treat the first 0.5 inches (1.27 cm) of runoff, the required water quality volume is 1,815 cubic feet per acre (127 m<sup>3</sup>/ha) of impervious area. For facilities designed to capture and treat the first 1.0 inch (2.54 cm) of runoff, the required water quality volume is 3,630 cubic feet per acre (254 m<sup>3</sup>/ha) of impervious area. The water quality volume must be ponded behind the check dams so that it can be filtered through the soil media.

6-1308.5B Check dams shall be provided along the length of the swale to provide storage of the water quality volume. The maximum height of check dams shall be 1.5 feet (457 mm). Check dams shall be located and sized such that the ponded water does not reach the toe of the next upstream check dam or create a tailwater condition on incoming pipes. The length of the channel segment over which water is ponded is a function of the slope of the swale and the height of the check dam computed as follows:

$$L = h / s$$

Where:

- L = length of channel segment (ft)
- h = height of check dam (ft)
- s = channel slope (ft/ft)

Channel segment lengths for various combinations of check dam height and channel slope that may be used for preliminary design are listed in Table 6.35. In determining the minimum spacing between check dams, add 5 feet (1.5 m) to the computed channel segment length to assure that the ponded water does not reach the toe of the next upstream check dam.

Table 6.35  
Channel Segment Length ft (m)

		Check Dam Height ft (cm)		
		0.5 (15)	1.0 (31)	1.5 (46)
Channel Slope %	1	50 (15.2)	100 (30.5)	150 (45.7)
	2	25 (7.1)	50 (15.2)	75 (22.9)
	3	16.7 (5.1)	33.3 (10.2)	50 (15.2)
	4	12.5 (3.8)	25 (7.1)	37.5 (11.4)
	5	10 (3.0)	20 (6.1)	30 (9.1)

6-1308.5C The volume stored behind a check dam is the average channel cross-section area at the ponding elevation multiplied by the length of the channel reach subject to ponding. Because the channel cross-section area is zero at the head of the reach, the average cross-section area is one half of the channel cross-section area at the low point of the check dam. The storage volume provided behind an individual check dam is computed as follows:

$$V_s = L \times 0.5A_s$$

Where:

- $V_s$  = volume of storage (ft<sup>3</sup>)
- L = length of channel segment (ft)
- $A_s$  = cross-section area (ft<sup>2</sup>) at the check dam

The channel cross-section area for a trapezoidal channel is computed as follows:

$$A = by + Zy^2$$

Where:

- b = bottom width
- y = flow depth
- Z = side slope length per unit height (e.g., Z = 3 if side slopes are 3H:1V)

The channel cross-section area of a trapezoidal channel with 3:1 side slopes for various combinations of check dam height and bottom width that may be used for preliminary design are listed in Table 6.36.

Table 6.36  
Channel Cross-section Area ft<sup>2</sup> (m<sup>2</sup>)

		Check Dam Height ft (cm)		
		0.5 (15)	1.0 (31)	1.5 (46)
Bottom Width ft (m)	2 (0.6)	1.75 (0.16)	5.0 (0.46)	9.75 (0.91)
	3 (0.9)	2.25 (0.21)	6.0 (0.56)	11.25 (1.05)
	4 (1.2)	2.75 (0.26)	7 (0.65)	12.75 (1.18)
	5 (1.5)	3.25 (0.30)	8 (0.74)	14.25 (1.32)
	6 (1.8)	3.75 (0.35)	9 (0.84)	15.75 (1.46)
	7 (2.1)	4.25 (0.39)	10 (0.93)	17.25 (1.60)
	8 (2.4)	4.75 (0.44)	11 (1.02)	18.75 (1.74)
	9 (2.7)	5.25 (0.49)	12 (1.11)	20.25 (1.88)
	10 (3.0)	5.75 (0.53)	13 (1.21)	21.75 (2.02)

6-1308.6 Water Quality Design Flow Method.

6-1308.6A For grass swales that function primarily as conveyance systems, swale design for water quality treatment is based on the peak flow from a 2 inch (508 mm) 24-hour storm. The peak water quality flow should be increased along the swale length to reflect inflows. If a single design flow is used, the flow at the outlet shall be used.

6-1308.6B The peak water quality flow shall be conveyed at a maximum depth equal to or less than 3 inches (762 mm).

6-1308.6C The maximum velocity for the peak water quality flow shall be 1.0 ft/sec (0.3 m/sec). Flow velocity is computed using the continuity equation:

$$V_{wq} = Q_{wq} / A_{wq}$$

Where:

$V_{wq}$  = design flow velocity (ft/sec)

$Q_{wq}$  = design flow (cfs)

$A_{wq}$  = cross-sectional area (ft<sup>2</sup>) of flow at design depth

6-1308.6D The minimum hydraulic residence time (i.e. the time for water to travel the full length of the swale) shall be 18 minutes. The minimum hydraulic residence time may be reduced to 9 minutes if the majority of flow enters at the head of the swale. The swale length required to achieve a minimum hydraulic residence time of 18 minutes (1080 seconds) is:

$$L = 1080V_{wq}$$

Where:

$L$  = minimum swale length (ft)

$V_{wq}$  = design flow velocity (ft/sec)

6-1308.6E The minimum swale length for swales designed using the water quality design flow method shall be 100 feet

(30.5 m). The minimum length may be achieved with multiple swale segments connected by culverts with energy dissipators.

1308.7 Underdrains. Underdrains shall consist of pipe  $\geq$  6 inch (152 mm) in diameter placed in a layer of washed VDOT #57 stone. There shall be a minimum of 2 inches (51 mm) of gravel above and below the pipe. The underdrain shall begin within 10 feet (3 m) of the upstream boundary of the swale. Underdrains shall be separated from the soil media by geotextile fabric or a 2-3 inch (51-76 mm) layer of washed VDOT #8 stone or 1/8-3/8 inch (3.2-9.5 mm) pea gravel. Underdrain pipe shall be perforated. All stone shall be washed with less than 1% passing a #200 sieve.

6-1308.8 Cleanouts. Cleanouts shall be placed every 100 feet (30.5 meters) along the length of the swale beginning at the upper end of the swale with a minimum of one cleanout per swale. Cleanouts shall be a minimum of 6 inches (152 mm) in diameter with a screw, or flange type cap to discourage vandalism and tampering. Cleanouts shall be nonperforated pipe except for the portion below the planting soil bed which must be perforated. For swales with check dams, the cap shall be above the BMP water surface elevation. For swales without check dams, the cap shall be above the ground surface.

6-1308.9 Materials Specifications.

6-1308.9A The bioretention soil media shall meet the requirements of § 6-1307.9A. Each vegetated swale shall have a minimum of one soil test performed on the final soil mixture. Test results and materials certifications shall be submitted to DPWES prior to bond release.

6-1308.9B Mulch shall meet the requirements of § 6-1307.9B.

6-1308.9C Underdrains shall meet the requirements of § 6-1307.9C.



6-1308.9D Filter fabric. Filter fabric shall meet the requirements of § 6-1307.9D.

6-1308.9E Check dams. Check dams may be constructed of non-erosive material such as wood, gabions, rip-rap, or concrete. Earthen berms or bio-logs also may be used to create check dams. Whatever material is used, check dams shall be designed to prevent erosion where the check dams intersect the channel side walls. Check dams shall be anchored into the swale wall a minimum of 2 feet (0.6 m) on each side with the toe protected by a suitable nonerodible material (e.g. stone). A notch or depression shall be placed in the top of the check dam to allow the 2-year flow to pass without coming into contact with the check dam abutments.

6-1308.10 Vegetated Swale Planting Plans.

6-1308.10A Planting plans are required for all vegetated swales planted with a mixture of shrubs, perennial herbaceous plants, and trees (optional). Planting plans are not required for vegetated swales only planted with grass.

6-1308.10B Vegetated swale planting plans and specifications shall be prepared by a certified landscape architect, horticulturist, or other qualified individual who has knowledge of the environmental tolerance, ecological functions, and ecological impacts of plant species. Planting plans shall be prepared in accordance with the requirements of § 12-0700.

6-1308.10C A mixture of shrubs and perennial herbaceous plants with a high density of fibrous roots is required. The use of trees is optional. Selected plants must be able to tolerate highly variable moisture conditions, generally dry with brief periods of inundation, retard and withstand stormwater flows, and filter pollutants. Depending on site conditions, selected plants also must be able to

tolerate exposure to wind and sun, as well as salt and toxins in runoff from roads, parking lots, and driveways. The use of native plant species is preferred. The acceptability of proposed plant materials will be determined by the Director. Guidance on the use and selection of plants for vegetated swales is available from the Urban Forest Management Division.

6-1308.10D Plant materials shall meet the requirements of § 6-1307.10C and § 6-1307.10D.

6-1308.10E The planting plan shall provide for plant community diversity and should consider aesthetics from plant form, color, and texture year-round. The vegetated swale design and selection of plant material shall serve to visually link the facility into the surrounding landscape. If trees and shrubs are part of the design, woody plant species shall not be placed directly within the inflow section of the swale.

6-1308.10F All plantings must be well established prior to release of the conservation deposit. Nursery stock trees and shrubs required by the approved plan shall be viable (healthy and capable of developing a trunk and branch structure typical for their species) at the time the conservation deposit is released.

6-1308.10G Design Guidelines for Vegetated Swale Planting Plans.

6-1308.10G(1) The facility should be considered as a mass planting bed with plants that have ornamental characteristics linking it to the surrounding landscape;

6-1308.10G(2) The facility should contain a variety of plant species which will add interest to the facility with each changing season;

6-1308.10G(3) A mixture of shrubs and perennial herbaceous groundcover at an

approximate ratio of 25% shrubs and 75% perennials shall be planted;

6-1308.10G(4) If trees are part of the design, only small ornamental trees may be used (Category I & II per Table 12.7). Trees may be substituted for shrubs up to an approximate ratio of 10% trees, 20% shrubs, and 70% perennials;

6-1308.10G(5) The plants shall be placed along the bottom of the swale. The side slopes of the swale shall be fully stabilized with vegetation. Spacing of plant material is species specific and will be subject to review and approval of the Director. In general the facility shall be planted at a density that the vegetation will cover 80-90% of the facility after the second growing season.

6-1308.11 Grassed Swale Vegetation. A dense cover of water-tolerant, erosion-resistant grass must be established. The selection of an appropriate species or mixture of species is based on several factors including climate, soils, topography, and sun tolerance. Grasses used in swales shall have the following characteristics: a deep root system to resist scouring; a high stem density, with well-branched top growth; water-tolerance; resistance to being flattened by runoff; and an ability to recover growth following inundation. Swales shall be sodded and pegged to provide immediate stabilization of the swale.

6-1308.12 Construction Specifications.

6-1308.12A The owner shall provide for inspection during construction of the facility by a licensed professional (In accordance with standard practice, the actual inspections may be performed by an individual under responsible charge of the licensed professional). The licensed professional shall certify that the facility was constructed in accordance with the approved plans. The licensed professional's certification along with any material delivery tickets and certifications from the material suppliers and results of

the tests and inspections required under § 6-1308.9A, § 6-1308.12D, and § 6-1308.12J shall be submitted to the County prior to bond release. For projects requiring as-built plans, the required certification and supporting documents shall be submitted with or incorporated in the as-built plans. For projects that do not require as-built plans, the required certification and supporting documents shall be submitted with the RUP or non-RUP request.

6-1308.12B Vegetated swales shall be constructed after the drainage area to the facility is completely stabilized. Erosion and sediment controls for construction of the facility shall be installed as specified in the erosion and sediment control plan.

6-1308.12C The components of the soil media shall be thoroughly mixed until a homogeneous mixture is obtained. It is preferable that the components of the soil media be mixed at a batch facility prior to deliver to the site. The soil media shall be moistened, as necessary, to prevent separation during installation.

6-1308.12D The soil media shall be tested for pH, organic matter, and soluble salts prior to installation. If the results of the tests indicate that the required specifications are not met, the soil represented by such tests shall be amended or corrected as required and retested until the soil meets the required specifications. If the pH is low, it may be raised by adding lime. If the pH is too high, it may be lowered by adding iron sulfate plus sulfur.

6-1308.12E The soil media may be placed by mechanical methods with minimal compaction in order to maintain the porosity of the media. Spreading shall be by hand. The soil media shall be placed in 8-12 inch (203-305 mm) lifts with no machinery allowed over the soil media during or after construction. The soil media should be overfilled above the proposed surface elevation as needed to allow for natural settlement. Lifts may be

lightly watered to encourage settlement. After the final lift is placed, the soil media shall be raked to level it, saturated, and allowed to settle for at least one week prior to installation of plant materials.

6-1308.12F Fill for earthen check dams shall consist of clean material free of organic matter, rubbish, frozen soil, snow, ice, particles with sizes larger than 3 inches (76 mm), or other deleterious material. Fill shall be placed in 8-12 inch (203-305 mm) lifts and compacted to prevent settlement. Compaction equipment shall not be allowed within the facility on the soil bed. The top of the check dam shall be constructed level at the design elevation.

6-1308.12G Plant material shall be installed per § 12-0805.

6-1308.12H Planting shall take place after construction is completed and during the following periods: March 15 through June 15 and September 15 through November 15 unless otherwise approved by the Director.

6-1308.12I All areas surrounding the facility that are graded or denuded during construction of the facility and are to be planted with turf grass shall be sodded.

6-1308.12J Vegetated swales designed to capture and treat the water quality volume shall be inspected at 12-24 and 36-48 hours after a significant rainfall [0.5-1.0 inch (1.27-2.54 cm)] or artificial flooding to determine that the facility is draining properly. Results of the inspection shall be provided to DPWES prior to bond release.

6-1308.13 Plan Submission Requirements.

6-1308.13A Plan view(s) with topography at a contour interval of no more than one foot and spot elevations throughout the facility showing all hydraulic structures including underdrains.

6-1308.13B Typical cross section(s) of the swale showing the following: dimensions of swale, underdrain, soil media, underlying gravel layer, filter fabric, groundwater table, and bedrock. Cross section(s) of the check dams.

6-1308.13C Profile showing the following: invert of the swale, gravel underdrain and pipe, groundwater table, bedrock, and check dams.

6-1308.13D Detail(s) of check dams.

6-1308.13E Plant schedule and planting plan specifying species, quantity of each species, stock size, type of root stock to be installed and amount of tree cover claimed for each tree species or spacing of shrubs and perennials within facility. Planting plan shall be in conformance with § 12-0700.

6-1308.13F Sizing computations for the facility including volume of storage, channel cross-section, and spacing of check dams required and provided.

6-1308.13G Hydrologic and hydraulic calculations for the swale.

6-1308.13H Field run soil borings used to determine the elevation of the groundwater table and/or bedrock.

6-1308.13I A discussion of the outfalls from the facility is to be included in the outfall narrative.

6-1308.13J Construction and materials specifications.

6-1308.14 Vegetated Swale Water Quality Volume Design Example:

6-1308.14A Given:

Drainage area to the swale = 30,000 ft<sup>2</sup>;  
Impervious area ( $A_i$ ) = 10,000 ft<sup>2</sup>;  
Slope of swale ( $s$ ) = 2.5 %  
Length of swale = 200 ft

6-1308.14B Determine the required check dam height and spacing and channel cross-section for a water quality volume (WQ<sub>v</sub>) of 0.5 inch per impervious acre (1,815 ft<sup>3</sup>).

6-1308.14B(1) The water quality volume is:

$$\begin{aligned} WQ_v &= 1,815 \text{ ft}^3 (10,000 \text{ ft}^2 / 43,560 \text{ ft}^2) \\ &= 417 \text{ ft}^3 \end{aligned}$$

6-1308.14B(2) Select height and spacing of check dams. For a channel slope of 2.5%, the channel segment lengths subject to ponding for check dam heights of 0.5, 1.0, and 1.5 feet are:

$$\begin{aligned} L &= h / s \\ &= 0.5 \text{ ft} / 0.025 = 20 \text{ ft} \\ &= 1.0 \text{ ft} / 0.025 = 40 \text{ ft} \\ &= 1.5 \text{ ft} / 0.025 = 60 \text{ ft} \end{aligned}$$

To determine the minimum spacing between check dams, add 5 feet to the computed channel segment length to assure that the ponded water does not reach the toe of the next upstream check dam. To determine the number of check dams, divide the total channel length by the minimum spacing and round down to the nearest whole number. If the computed value is a whole number, subtract one. This gives us minimum spacings of 25, 45, and 65 feet for check dam heights of 0.5, 1.0, and 1.5 feet respectively.

The volume of water ponded behind an individual check dam is the required water quality volume divided by the number of check dams. For 7, 4, and 3 check dams, the required storage volumes are 59.6, 104.3, and 139 ft<sup>3</sup> respectively.

The minimum required cross-section areas are:

$$\begin{aligned} A_x &= 2.0(V_s / L) \\ &= 2.0(59.6 \text{ ft}^3 / 20 \text{ ft}) = 5.96 \text{ ft}^2 \\ &= 2.0(104.3 \text{ ft}^3 / 40 \text{ ft}) = 5.22 \text{ ft}^2 \\ &= 2.0(139.0 \text{ ft}^3 / 60 \text{ ft}) = 4.64 \text{ ft}^2 \end{aligned}$$

From Table 6.36, it can be seen that a trapezoidal channel with 0.5 foot high check dams would need to exceed the allowable channel bottom width to provide the required storage volume. A trapezoidal channel with a 3 foot bottom width and 1.0 foot high check dams would work as would a trapezoidal channel with a 2 foot bottom width and 1.5 foot high check dams. The results of the above computations are summarized in Table 6.37.

Table 6.37  
Example Problem

	Check Dam Height		
	0.5	1.0	1.5
Number of Check Dams	7	4	3
Spacing of Check Dams	25 ft	45 ft	65 ft
Storage Volume (V <sub>s</sub> )	59.6 ft <sup>3</sup>	104.3 ft <sup>3</sup>	139.0 ft <sup>3</sup>
Cross-section Area (Required)	5.96 ft <sup>2</sup>	5.22 ft <sup>2</sup>	4.64 ft <sup>2</sup>
Cross-section Area (Provided)	--	6.0 ft <sup>2</sup>	9.75 ft <sup>2</sup>
Channel bottom width	--	3 ft	2 ft

6-1308.15 Vegetated Swale Water Quality Flow Design Example.

6-1308.15A Given:

Drainage area to the swale = 30,000 ft<sup>2</sup>;  
 Impervious area (A<sub>i</sub>) = 10,000 ft<sup>2</sup>;  
 Hydrologic Soil Group (HSG) of pervious area = "C"  
 Time of concentration T<sub>c</sub> = 0.25 hr  
 Time of travel T<sub>t</sub> = 0.15 hr per 100 ft  
 Slope of swale (s) = 2.5 %  
 Length of swale = 200 ft

Assume that flow enters uniformly along the length of the swale. Therefore, the required minimum hydraulic residence time required is 18 minutes (§ 6-1308.6D).

6-1308.15B Calculate the design flow for a 2 inch 24 hour storm using standard NRCS methods. The swale was modeled as 2 subareas and two 100 foot long reaches.  $T_c$  for the first 100 foot reach of the swale consists of 6 minutes for sheet flow to the swale and 9 minutes travel time in the swale. The resulting design flow is 0.54 cfs at the outlet of the swale. [Note that computation of the 2-year and 10-year storm flows should use a combined  $T_c + T_t$  of 0.1 hr because of the lower "n" value and travel time in the swale at higher flow depths.]

6-1308.15C Flow in the swale is calculated based on Manning's equation for open channel flow.

$$Q = \frac{1.49AR^{0.67}s^{0.5}}{n}$$

Where:

- Q = flow rate (cfs)
- n = Manning's roughness coefficient (unitless)
- A = cross-sectional area of flow (ft<sup>2</sup>)
- R = hydraulic radius (ft)
- s = longitudinal slope (ft/ft)

For shallow flow depths in swales, channel side slopes may be ignored in the initial estimation of the bottom width. The following equation (a simplified form of Manning's equation) may be used to estimate the swale bottom width:

$$b = Q_{wq}n_{wq} / 1.49y^{1.67}s^{0.5}$$

Where:

- b = bottom width of swale (ft)
- $Q_{wq}$  = water quality design flow (cfs)
- $n_{wq}$  = Mannings roughness coefficient for shallow flow conditions (unitless)

- y = design flow depth (ft)
- s = longitudinal slope (ft/ft)

6-1308.15D The design flow velocity is computed using the continuity equation.

$$V_{wq} = Q_{wq} / A_{wq}$$

Where:

- $V_{wq}$  = design flow velocity (ft/sec)
- $A_{wq} = by + Zy^2$  = cross-sectional area (ft<sup>2</sup>) for a trapezoidal cross-section
- Z = side slope length per unit height (e.g., Z = 3 if side slopes are 3H:1V)

6-1308.15E Determine the maximum allowable velocity for a hydraulic residence time of 18 minutes.

$$\begin{aligned} V_{wq} &= L/1080 \\ &= 200 \text{ ft}/1080 \text{ sec} \\ &= 0.19 \text{ ft/sec} \end{aligned}$$

6-1308.15F Compute the estimated bottom width and design flow velocity using a flow depth of 3 inches (0.17 ft).

$$\begin{aligned} b &= 0.54(0.2)/1.49(0.25^{1.67})(0.025^{0.5}) \\ &= 4.6 \text{ ft} \end{aligned}$$

$$\begin{aligned} V_{wq} &= 0.54 / (4.6*0.25 + 3*0.25^2) \\ &= 0.40 \text{ ft/sec} \end{aligned}$$

0.40 ft/sec > 0.19 ft/sec Not OK

6-1308.15G Recompute the estimated bottom width and design flow velocity using a flow depth of 2 inches (0.17 ft).

$$\begin{aligned} b &= 0.54(0.2)/1.49(0.17^{1.67})(0.025^{0.5}) \\ &= 8.8 \text{ ft} \end{aligned}$$

$$\begin{aligned} V_{wq} &= 0.54 / (8.8*0.17 + 3*0.17^2) \\ &= 0.34 \text{ ft/sec} \end{aligned}$$

0.34 ft/sec > 0.19 ft/sec Not OK

6-1308.15H At this point it is clear that in order to achieve the 18 minute hydraulic residence time required the slope of the channel must be reduced or a longer

channel constructed. We can do both simultaneously by constructing a channel with the same upstream and downstream invert elevations along a sinusoidal path. Try a 300 foot long channel. The resulting slope is 1.7%. The maximum allowable velocity for the channel would now be:

$$\begin{aligned} V_{wq} &= L/1080 \\ &= 300 \text{ ft}/1080 \text{ sec} \\ &= 0.29 \text{ ft/sec} \end{aligned}$$

6-1308.15I Recompute the estimated bottom width and design flow velocity using a flow depth of 2 inches (0.17 ft) and a slope of 1.7%.

$$\begin{aligned} b &= 0.54(0.2)/1.49(0.17^{1.67})(0.017^{0.5}) \\ &= 10.7 \text{ ft} \end{aligned}$$

10.7 ft > 10 ft Not OK

$$\begin{aligned} V_{wq} &= 0.54 / (10.7*0.17 + 3*0.17^2) \\ &= 0.28 \text{ ft/sec} \end{aligned}$$

0.28 ft/sec < 0.29 ft/sec OK

6-1308.15J Although the velocity is acceptable, the swale bottom width is greater than the maximum allowable width. Repeat the procedure of lengthening the swale until an acceptable result is achieved.

### 6-1309 Tree Box Filters

6-1309.1 A tree box filter is a type of bioretention filter contained in a precast or cast-in-place concrete structure. The principal components of a tree box filter are an inlet structure, a concrete box, a tree grate, plants that tolerate fluctuations in soil moisture and temporary ponding of water, a mulch layer, an engineered soil media, and an underdrain in a gravel layer that is connected to the storm drain system. The soil media is highly permeable and well drained. Water quality control is provided by filtering storm water runoff through the soil media and mulch, biological and chemical reactions in the soil, mulch, and root zone, and plant uptake.

6-1309.1A Tree box filters are best suited for small drainage areas that have low sediment loads such as parking lots, courtyards, and along privately maintained streets.

6-1309.1B Trees in tree box filters may be used to meet the requirements of Article 13 of the Zoning Ordinance and § 12-0000 *et seq.* of the PFM. Minimum planting area and minimum distance to barriers as required by § 12-0702.1B(2) must be met to use trees in tree box filters to meet tree cover requirements. Use of some small trees may be possible (Category I and II).

6-1309.2 Location and Siting.

6-1309.2A In residential areas, tree box filters and their appurtenant structures must be located on Home Owner Association (or "common") property and may not be located on individual buildable single-family attached or detached residential lots or any part thereof.

6-1309.2B Tree box filters may be located in the right-of-way subject to approval by VDOT.

6-1309.2C Tree box filters shall not be located in the vicinity of loading docks, vehicle maintenance areas, or outdoor storage areas, where there is the potential for high concentrations of hydrocarbons, toxics, or heavy metals in stormwater runoff unless effective pre-treatment is provided to reduce the concentrations.

6-1309.2D The maximum impervious area draining to a tree box filter shall be 0.25 acre (0.1 hectares).

6-1309.3 Maintenance.

6-1309.3A Tree box filters and their appurtenant structures must be privately maintained and a private maintenance agreement must be executed before the construction plan is approved. Tree box filters may not be located in County storm

drainage easements. The above does not preclude the use of tree box filters by the County on County owned property.

6-1309.3B Maintenance access must be provided for all tree box filters. Access routes shall be depicted on plans for all facilities not located in parking lots or along streets.

6-1309.3C Tree box filters shall be stenciled (or a plaque provided) on the inside of the box in a location clearly visible upon removal of the tree grate designating the tree box as a water quality management facility. The stenciling or plaque shall state that the facility is a water quality management facility, water may pond after a storm, and the facility is not to be disturbed except for required maintenance.

6-1309.4 General Design Requirements.

6-1309.4A Water Quality Volume. For facilities designed to capture and treat the first 0.5 inches (1.27 cm) of runoff, the required water quality volume is 1,815 cubic feet per acre (127 m<sup>3</sup>/ha) of impervious area. For facilities designed to capture and treat the first 1.0 inch (2.54 cm) of runoff, the required water quality volume is 3,630 cubic feet per acre (254 m<sup>3</sup>/ha) of impervious area. The water quality volume must be captured and filtered through the system.

6-1309.4B Flow Rate Based Design. For facilities whose treatment capacity is based on a maximum flow rate, the design methodology shall be approved by the Director.

6-1309.4C Tree box filters shall be located adjacent to a storm drain inlet to capture runoff that bypasses the system during heavy rainfall events.

6-1309.4D The top of the structure shall include a grate that will allow vegetation to grow through it and that is capable of supporting H-20 loads. The grate shall be removable for maintenance.

6-1309.4E The inlet structure shall be a standard curb inlet meeting VDOT requirements. A stone energy dissipater or other approved method shall be provided at the end of the inlet throat running along the entire length of the inlet at the surface of the soil media.

6-1309.4F Tree boxes shall be constructed of precast or cast-in-place reinforced concrete meeting VDOT requirements for drainage structures.

6-1309.4G To reduce construction costs, the bottom of the box may be left open in areas where there is potential for infiltration.

6-1309.4H The maximum surface storage depth from the top of the mulch layer to the bottom of the grate shall be 1 foot (305 mm).

6-1309.4I An underdrain connected to the storm drain system shall be provided for all tree box filters. The outfall of all underdrains must be in conformance with the adequate drainage requirements of § 6-0200 *et seq.*

6-1309.4J The minimum soil media depth shall be 2.5 feet (762 mm). The bottom of the soil layer must be a minimum of 4 inches (102 mm) below the root ball of plants to be installed. A layer of 2-3 inches (51-76 mm) of mulch shall be placed on top of the soil media.

6-1309.4K Variations of the tree box filter design in Plate 90-6 (90-M6) may be approved by the Director provided the facility meets all of the requirements in § 6-1309 *et seq.*

6-1309.5 Filter Bed Design. The required surface area of the filter is based on the volume of water to be treated and the available storage in the ponding area computed as follows:

$$A_f = WQ_v/h_f$$

Where:

$A_f$  = area of filter (ft<sup>2</sup>)

$WQ_v$  = water quality volume (ft<sup>3</sup>)

$h_f$  = maximum ponding depth (ft)

6-1309.6 Underdrains. Underdrains shall consist of perforated pipe  $\geq$  4 inch (102 mm) in diameter placed in a layer of washed VDOT #57 stone. There shall be a minimum of 2 inches (51 mm) of gravel above and below the pipe. Underdrains shall be laid at a minimum slope of 0.5%. Underdrains shall extend the length of the box from one wall to within 6 inches (152 mm) of the opposite wall and may be centered in the box or offset to one side. Underdrains shall be separated from the soil media by geotextile fabric or a 2-3 inch (51-76 mm) layer of washed VDOT #8 stone or 1/8–3/8 inch (3.2-9.5 mm) pea gravel. Underdrains shall include a cleanout with a locking cap that extends 6 inches (152 mm) above the soil media and is accessible by removing the grate. Cleanouts shall be nonperforated pipe equal to or greater in diameter than the underdrain pipe. All stone shall be washed with less than 1% passing a #200 sieve.

6-1309.7 Materials Specifications.

6-1309.7A The bioretention soil media shall meet the requirements of § 6-1307.9A. A minimum of one soil test shall be performed on the final soil mixture. Test results and materials certifications shall be submitted to DPWES prior to bond release.

1309.7B Mulch shall meet the requirements of § 6-1307.9B.

6-1309.7C Underdrains shall meet the requirements of § 6-1307.9C.

6-1309.7D Filter fabric. Filter fabric shall meet the requirements of § 6-1307.9D.

6-1309.8 Tree Box Filter Planting.

6-1309.8A A tree box filter shall be planted with a small tree or shrub that is able to tolerate highly variable moisture conditions, generally dry with brief periods of inundation. The selected plants must not have a root zone density or characteristics that will rapidly displace the soils or clog the underdrain. Depending on site conditions, selected plants also must be able to tolerate exposure to wind and sun, as well as salt and toxins in runoff from roads, parking lots, and driveways. The use of native plant species is preferred. The acceptability of proposed plant materials will be determined by the Director. Guidance on the use and selection of plants for tree box filters is available from the Urban Forest Management Division.

6-1309.8B Plant materials shall meet the requirements of § 6-1307.10C and § 6-1307.10D.

6-1309.8C All plantings must be well established prior to release of the conservation deposit. Nursery stock trees and shrubs required by the approved plan shall be viable (healthy and capable of developing a trunk and branch structure typical for their species) at the time the conservation deposit is released.

6-1309.9 Construction Specifications.

6-1309.9A The owner shall provide for inspection during construction of the facility by a licensed professional (In accordance with standard practice, the actual inspections may be performed by an individual under responsible charge of the licensed professional). The licensed professional shall certify that the facility was constructed in accordance with the approved plans. The licensed professional's certification along with any material delivery tickets and certifications from the material suppliers and results of the tests and inspections required under § 6-1309.7A, § 6-1309.9D, and § 6-1309.9H shall be submitted to the County prior to bond release. For projects requiring as-built plans, the required



certification and supporting documents shall be submitted with or incorporated in the as-built plans. For projects that do not require as-built plans, the required certification and supporting documents shall be submitted with the RUP or non-RUP request.

6-1309.9B Tree box filters shall be constructed after the drainage area to the facility is completely stabilized. Erosion and sediment controls for construction of the facility shall be installed as specified in the erosion and sediment control plan. The concrete box may be installed with the other elements of the storm drainage collection system provided that it is flushed of any accumulated sediments prior to installation of the underdrain, filter fabric, and soil media components.

6-1309.9C The components of the soil media shall be thoroughly mixed until a homogeneous mixture is obtained. It is preferable that the components of the soil media be mixed at a batch facility prior to delivery to the site. The soil media shall be moistened, as necessary, to prevent separation during installation.

6-1309.9D The soil media shall be tested for pH, organic matter, and soluble salts prior to installation. If the results of the tests indicate that the required specifications are not met, the soil represented by such tests shall be amended or corrected as required and retested until the soil meets the required specifications. If the pH is low, it may be raised by adding lime. If the pH is too high, it may be lowered by adding iron sulfate plus sulfur.

6-1309.9E The soil media shall be placed by hand with minimal compaction in order to maintain the porosity of the media. Spreading shall be by hand. The soil media shall be placed in 8-12 inch (203-305 mm) lifts with no machinery allowed over the soil media during or after construction. The soil media should be overfilled above the proposed surface elevation as needed to allow for natural

settlement. Lifts may be lightly watered to encourage settlement. After the final lift is placed, the soil media shall be raked to level it, saturated, and allowed to settle for at least one week prior to installation of plant materials.

6-1309.9F Plant material shall be installed per § 12-0805.

6-1309.9G Planting shall take place after construction is completed and during the following periods: March 15 through June 15 and September 15 through November 15 unless otherwise approved by the Director.

6-1309.9H The facility shall be inspected at 12-24 hours after a significant rainfall [0.5-1.0 inch (1.27-2.54 cm)] or artificial flooding to determine that the facility is draining properly. Results of the inspection shall be provided to DPWES prior to bond release.

6-1309.10 Plan Submission Requirements.

6-1309.10A Plan view(s) with topography at a contour interval of no more than one foot and spot elevations throughout the facility showing all hydraulic structures including underdrains.

6-1309.10B Cross section of the facility showing the following: elevations and dimensions of the structure, inlet, outlet, underdrain, soil media, and underlying gravel layer, and filter fabric.

6-1309.10C Plant schedule specifying species, quantity of each species, stock size, type of root stock to be installed and amount of tree cover claimed for each tree species. Planting schedule shall be in conformance with § 12-0701.5.

6-1309.10D Sizing computations for the facility including volume of storage and surface area of facility required and provided.

6-1309.10E Hydrologic calculations for the facility.

6-1309.10F Design calculations and specifications for all hydraulic structures including inlet structures and underdrain piping.

6-1309.10G A discussion of the outfalls from the facility is to be included in the outfall narrative.

6-1309.10H Construction and materials specifications.

6-1309.11 Tree Box Filter Design Example:

6-1309.11A Given:

Impervious area ( $A_i$ ) draining to the facility = 1,500 ft<sup>2</sup>;  
Maximum ponding depth ( $h_f$ ) = 1.0 ft

6-1309.11B Determine the required area of the filter bed ( $A_f$ ) for a water quality volume ( $WQ_v$ ) of 0.5 inch per impervious acre (1,815 ft<sup>3</sup>).

6-1309.11C The water quality volume is:

$$WQ_v = 1,815 \text{ ft}^3 (1,500 \text{ ft}^2 / 43,560 \text{ ft}^2) \\ = 62.5 \text{ ft}^3$$

6-1309.11D The area of the filter bed is:

$$A_f = WQ_v/h_f \\ = 62.5/1.0 = 62.5 \text{ ft}^2$$

6-1309.11E The minimum size tree filter box would be:

$$\sqrt{62.5} = 7.9 \text{ ft}$$

Use a square 8 ft X 8 ft box. A rectangular 6 ft X 11 ft box could also be used.

## 6-1310 Vegetated Roofs

6-1310.1 A vegetated roof (a.k.a. green roof) is a roof system consisting of the structural components of the roof, a waterproof membrane, a drainage layer, a layer of growth media, and plants.

Depending on the type of plants and the waterproof membrane specified, an irrigation system and a root barrier also may be provided. Vegetated roofs reduce the peak rate and volume of stormwater runoff through interception of rainfall and evapotranspiration. Vegetated roofs improve water quality by capturing and filtering airborne depositional pollutants and by plant uptake of dissolved pollutants. Additionally, a vegetated roof provides reductions in energy use for heating and cooling, improvements in air quality, and aesthetic benefits. Vegetated roofs are classified as extensive or intensive systems based on the depth of the growth media and function of the roof.

6-1310.1A Extensive systems are shallow systems, having a growth media depth of 3-6 inches (75-150 mm), a low unit weight, low construction cost, low plant diversity, and minimal maintenance requirements. Extensive systems are constructed when the primary purpose is to achieve environmental benefits and typically are only accessible for maintenance and inspection. Extensive systems may be constructed on slopes of up to 33%.

6-1310.1B Intensive systems have a growth media depth of 6 inches (150 mm) or greater, a greater unit weight, increased design sophistication and construction costs, increased plant diversity, greater water holding capacity, and increased maintenance requirements compared to extensive systems. Intensive systems often are accessible and provide an amenity for occupants of the building. Intensive systems may not be constructed on slopes greater than 10%.

## 6-1310.2 General Requirements.

6-1310.2A Vegetated roofs may be used on non-residential buildings (commercial, industrial, and institutional uses), parking structures, multi-family residential buildings including condominiums and

apartments, and mixed-use buildings with a residential component.

6-1310.2B Vegetated roofs may not be used on single family detached or attached units for the purpose of satisfying the detention or water quality control (BMP) requirements of the Subdivision or Zoning Ordinance. Vegetated roofs may not be used on single family detached units in nonbonded subdivisions to satisfy the BMP requirements of the Chesapeake Bay Preservation Ordinance.

6-1310.2C Vegetated roofs must be privately maintained and a private maintenance agreement must be executed before the construction plan is approved.

6-1310.2D Post-development hydrology. For hydrologic computations using the Rational Method, the runoff coefficient "C" values for vegetated roofs in Table 6.6 shall be used. For hydrologic computations using Natural Resource Conservation Service (NRCS) methods, a curve Number "CN" value of 65 shall be used for intensive systems and a value of 70 shall be used for extensive systems. Other values may be approved by the Director, depending on the composition and depth of the growth media and the slope of the roof, upon submission of a hydrologic analysis of the water retention capacity of the system.

### 6-1310.3 Design of Vegetated Roofs.

6-1310.3A Extensive vegetated roof systems shall have a minimum growth media depth of 3 inches (75 mm) and a maximum growth media depth of 6 inches (150 mm). The Director may approve growth media depths less than 3 inches for systems constructed on existing buildings when necessary because the structural design of the roof is not sufficient to carry the greater loads. Adjustments to the assigned runoff coefficients and curve numbers will be necessary to account for the reduced

water holding capacity of the growth media.

6-1310.3B Intensive vegetated roof systems shall have a minimum growth media depth of 6 inches (150 mm). A maximum growth media depth is not specified for intensive vegetated roof systems. Unless needed to accommodate small trees or large shrubs, the growth media depth should not be greater than 12 inches (300 mm). Intensive vegetated roof systems may include subareas with different growth media depths to accommodate different types of plants.

6-1310.3C The drainage layer below the growth media shall be designed to convey stormwater to the roof downspouts, conductors, and leaders without backing water up into the growth media. Roof areas draining to an individual roof drain may not exceed 4,300 ft<sup>2</sup> (400 m<sup>2</sup>) unless internal drainage conduits are provided. Internal drainage conduits shall be designed to convey the 10-year storm.

6-1310.3D Roof drains and emergency overflow measures shall be sized in accordance with the Virginia Uniform Statewide Building Code (VUSBC).

6-1310.3E Vegetated roofs shall have a minimum slope of 2% to provide for adequate drainage. The slope of extensive systems shall not be greater than 33%. The slope of intensive systems shall not be greater than 10%. Extensive systems with slopes equal to or greater than 17% will require supplemental slope stabilization measures (e.g. raised grids) to hold the growth media and plants in place.

6-1310.3F Access to vegetated roofs for maintenance and inspection shall be provided unless waived by the Director. Access shall be provided by an interior stairway through a penthouse or by an alternating tread device with a roof hatch or trap door not less than 16 square feet (1.5 m<sup>2</sup>) in area and having a minimum dimension of 24 inches (610 mm), or by a

terrace door with a minimum clear opening width of 32 inches (813 mm). The access requirement may be waived by the Director for roofs no greater than 12 feet (3.7 m) above finished grade and less than 1000 square feet (93 m<sup>2</sup>) in area.

6-1310.3G Provisions for the safety of maintenance and inspection workers (e.g. parapets, railings, secured rings for safety harnesses, etc.) shall be incorporated in the design of all roofs.

6-1310.3H A vegetation-free zone is recommended along the perimeter of the roof and around all roof penetrations to act as a fire break and to facilitate maintenance and inspection. This zone should be a minimum of 24 inches (61 cm) in width along the perimeter of the roof and a minimum of 12 inches (30.5 cm) around all roof penetrations. The width of the vegetation-free zone around the perimeter of the roof may be reduced from 24 inches (61 cm) to 12 inches (30.5 cm) where application of the 24 inch (61 cm) requirement would result in a reduction of the roof area available for greening of greater than 15%.

6-1310.4 Design and Construction Specifications of Vegetated Roof Components. Vegetated roofs typically consist of the structural components of the roof, a waterproof membrane, a root barrier (if required), a protective layer, a drainage layer, filter fabric, a layer of growth media, and plants. Vegetated roofs may also include an optional thermal insulation layer, a leak detection system, and an irrigation system. Specifications for the optional components of vegetated roofs are not provided herein but should meet any applicable VUSBC requirements. Variations on the vegetated roof system designs in Plates 91-6 and 92-6 (91M-6 & 92M-6) may be approved by the Director provided the facility meets all of the requirements of §6-1310 *et seq.*

6-1310.4A Waterproof membrane. The waterproof membrane that separates the drainage system and growth media from

the structural components of the roof can consist of several different systems including modified bitumen, rubberized asphalt, polyvinyl chloride (PVC), thermoplastic polyolephin (TPO), chlorosulfonated polyethylene (CSPE), and ethylene propylene diene monomer (EPDM) systems. Membranes impregnated with pesticides or herbicides are not allowed. Waterproofing must meet VUSBC requirements.

6-1310.4B Root barrier. A PVC, polypropylene, or polyethylene membrane  $\geq 30$  mil thick hot-air welded at the seams or approved equivalent is required to protect modified bitumen and rubberized asphalt waterproofing from root penetration. A root barrier is not required for PVC, EPDM, or CSPE membranes.

6-1310.4C Protective layer. A perforation resistant protective layer is required to protect the waterproofing and root barrier (if required) from damage. The protective layer shall be a polypropylene non-woven needled fabric with a density (ASTM D3776)  $\geq 16$  oz/yard<sup>2</sup> (542 gm/m<sup>2</sup>) and a puncture resistance (ASTM D4833)  $\geq 220$  lbs (979 N) or approved equivalent.

6-1310.4D Drainage layer. The drainage layer shall be a single or composite system capable of conveying stormwater that drains through the growth media. Drainage layers may be a granular drainage media, synthetic geocomposite, or synthetic mat and may include internal drain pipes.

6-1310.4D(1) Granular drainage media shall be a non-carbonate mineral aggregate meeting the requirements listed in Table 6.38.

Table 6.38 Granular Drainage Media Specifications

Saturated Water Permeability (ASTM E2396)	≥ 25 in/min (63.5 cm/min)
Total Organic Matter, by Wet Combustion (MSA)	≤ 1 %
Abrasion Resistance (ASTM C131)	≤ 25 % loss
Soundness (ASTM C88)	≤ 5 % loss
Porosity (ASTM C29)	≥ 25 %
pH	6.5 – 8.0
Grain-size Distribution (ASTM C136)	
Passing US #8 (2.36 mm) sieve	≤ 1%
Passing 1/4 in (6.350 mm) sieve	≤ 30%
Passing 3/8 in (9.525 mm) sieve	≥ 80%

6-1310.4D(2) For non-grid systems, a drainage system consisting of deformed polyethylene sheet with a transmissivity (ASTM D4716) greater than or equal to 24 gallons per minute per foot (298 liters per minute per meter) of width.

6-1310.4E Filter fabric. Filter fabric shall be a non-woven, root penetrable, needled, polypropylene geotextile meeting the requirements listed in Table 6.39. Heat-set or heat-calendared fabrics are not permitted.

Table 6.39 Filter Fabric Specifications

Unit Weight (ASTM D3776)	≤ 4.25 oz/yd <sup>2</sup> (144 gm/m <sup>2</sup> )
Grab Tensile Strength (ASTM D4632)	≥ 90 lbs (400 N)
Mullen Burst Strength (ASTM D3786)	≥ 135 lbs/in <sup>2</sup> (930 kPa)
UV Resistance (ASTM D4355)	70% strength after 500 hours
Permittivity (ASTM D4491)	≥ 2 sec <sup>-1</sup>

6-1310.4F Growth media. Growth media shall be a mineral and organic mixture that provides sufficient nutrients and water holding capacity to support the

proposed plant materials. Tables 6.40, 6.41, and 6.42 provide specifications for the growth media that must be adapted to the specific application by a competent professional.

Table 6.40 Growth Media Specifications

Total Organic Matter by Loss on Ignition (ASTM F1647, Method A)	3 - 15% (dry weight)
Maximum Water Capacity (ASTM E2399)	≥ 45 % (Vol.) for intensive systems ≥ 35 % (Vol.) for extensive systems
Non-capillary Pore Space (void ratio) at Field Capacity, 0.333 bar (MSA)	≥ 15% (Vol.)
Saturated Water Permeability (ASTM D2434)	≥ 0.7 in/hr (1.8 cm/hr) for intensive systems ≥ 1.4 in/hr (3.6 cm/hr) for extensive systems
pH	6.5 – 8.0
Nitrate + Ammonium, N (in CaCl <sub>2</sub> )	≤ 80 mg/l
Phosphorus, P <sub>2</sub> O <sub>5</sub> (in CAL)	≤ 200 mg/l
Potassium, K <sub>2</sub> O (in CAL)	≤ 700 mg/l
Magnesium, Mg (in CaCl <sub>2</sub> )	≤ 160 mg/l

Table 6.41 Mineral Fraction Grain-size Distribution (ASTM D422) for Intensive Sites

Clay ≤ 0.000079 in (0.002 mm)	3 - 10%
Silt ≤ 0.0029 in (0.075 mm)	10 – 17%
Passing US #60 (0.25 mm) sieve	10 – 40%
Passing US #18 (1.0 mm) sieve	30 – 100%
Passing 1/4 in (6.350 mm) sieve	70 – 100%
Passing 3/8 in (9.525 mm) sieve	90 – 100%

Table 6.42 Mineral Fraction Grain-size Distribution (ASTM D422) for Extensive Sites

Clay $\leq 0.000079$ in (0.002 mm)	0%
Silt $\leq 0.0029$ in (0.075 mm)	0 – 15%
Passing US #60 (0.25 mm) sieve	10 – 40%
Passing US #18 (1.0 mm) sieve	30 – 100%
Passing 1/4 in (6.350 mm) sieve	70 – 100%
Passing 3/8 in (9.525 mm) sieve	90 – 100%

6-1310.4G Plants. The planting plan and specifications shall be prepared by a certified landscape architect, horticulturist, or other individual who is knowledgeable about the environmental tolerance and ecological functions and impacts of plant species.

6-1310.4G(1) Plant materials selected shall be shallow rooted, self-sustaining, and tolerant of direct sunlight, drought, wind, and frost. Plant materials for extensive systems may include mosses, sedums, herbaceous plants, and grasses. Plant materials for intensive systems may include mosses, sedums, herbaceous plants, grasses, shrubs, and small trees. Invasive species that may disrupt or harm native plant communities shall not be used. The acceptability of proposed plant materials will be determined by the Director. Guidance on the use and selection of plants for vegetated roofs is available from the Urban Forest Management Division.

6-1310.4G(2) Plants may be installed by vegetation mats, plugs, potted plants, sprigs, or direct seeding.

6-1310.4G(3) The planting plan shall be designed to achieve 90 percent coverage within two years of installation.

6-1310.4H Measures for irrigation shall be provided to ensure plant viability during long periods of drought unless waived by the Director. At a minimum, a hose bib shall be provided for manual irrigation. If

automated irrigation is provided, the additional dead load shall be incorporated in the roof system design. The requirement to provide measures for irrigation may be waived by the Director for roofs no greater than 12 feet (3.7 m) above finished grade and less than 1000 square feet (93 m<sup>2</sup>) in area.

#### 6-1310.5 Construction Requirements.

6-1310.5A The owner shall provide for inspection during construction of the facility by a licensed professional (In accordance with standard practice, the actual inspections may be performed by an individual under responsible charge of the licensed professional). The licensed professional shall certify that the facility was constructed in accordance with the approved plans. The licensed professional's certification along with any material delivery tickets and certifications from the material suppliers shall be submitted to the County prior to bond release. For projects requiring as-built plans, the required certification and supporting documents shall be submitted with or incorporated in the as-built plans. For projects that do not require as-built plans, the required certification and supporting documents shall be submitted with the RUP or non-RUP request.

6-1310.5B Foot and equipment traffic on the roof shall be minimized. Traffic over the waterproof membrane must be strictly controlled until the protective layer and drainage layer are installed.

6-1310.5C The organic and mineral components of the growth media shall be thoroughly mixed prior to installation. It is preferable that the components of the growth media be mixed at a batch facility prior to delivery to the site. The media shall be moistened, as necessary, to prevent separation during installation.

6-1310.5D The growth media shall be soaked at a rate of 30 gallons (114 liters) per 100 square feet (9.3 m<sup>2</sup>) and allowed to drain thoroughly before planting.

6-1310.5E Erosion Control. A bio-degradable jute mesh with an aperture of 0.375 - 1.0 inches (9.525 - 25.4 mm) and a tensile strength (ASTM D4632)  $\geq$  20 pounds (89 N) or approved equivalent shall be provided when establishing plants from sprigs and/or seed.

6-1310.5F Plant installation shall occur during the following periods: March 15 through June 15 and September 15 through November 15 unless otherwise approved by the Director.

6-1310.5G Shrubs and potted plants must be hardened off adequately prior to planting.

6-1310.5H The roof should be checked for leakage, slippage of membranes and soil erosion after planting.

6-1310.5I Plantings must be well established prior to release of the conservation deposit. The conservation deposit will be held for a minimum of one year after installation of the plantings and shall only be released if the 90% coverage required by § 6-1310.4G(3) is achieved. If ninety percent coverage is not achieved, the area shall be replanted to achieve the minimum required coverage and the conservation deposit held for an additional year.

6-1310.6 Plan Submission Requirements.

6-1310.6A Plan view(s) showing facility dimensions, planting plan, layout for internal drains (if provided as part of the drainage layer), roof access, walkways, roof penetrations, and setbacks from roof lines.

6-1310.6B Cross section of proposed roof system showing the waterproof membrane, root barrier, protection layer, drainage layer, filter fabric, soil media depth, and emergency overflow system. See Plates 91-6 & 92-6 (91M-6 & 92M-6).

6-1310.6C Specifications for the waterproof membrane, root barrier (if provided), protection layer, drainage layer, filter fabric, and soil media.

6-1310.6D Plant list specifying species, size, and number of proposed plants, seeding rates, planting procedures, and specifications for erosion control.

6-1310.6E Construction requirements, sequence, and procedures including a list of certifications required to be provided to the County.

6-1310.6F Roof area in square feet (m<sup>2</sup>) that is vegetated.

6-1310.6G A note shall be placed on the cover sheet stating that the site plan includes a vegetated roof on the proposed building to meet stormwater and water quality control requirements and that construction of the vegetated roof is required with the building. The note shall also state that the building plans shall include a statement signed and sealed by the licensed professional submitting the building design that:

6-1310.6G(1) The vegetated roof design on the building plans is in conformance with the vegetated roof design on the approved site plan;

6-1310.6G(2) Additional requirements for all items such as roof membranes, drains, irrigation systems, and safety rails shall comply with the requirements of the Virginia Uniform Statewide Building Code;

6-1310.6G(3) Access to the vegetated roof has been provided in accordance with Public Facilities Manual § 6-1310.3F;

6-1310.6G(4) Provisions for the safety of maintenance and inspection workers have been incorporated in the design of the vegetated roof in accordance with Public Facilities Manual § 6-1310.3G; and

6-1310.6G(5) Manual or automated irrigation has been provided in accordance with Public Facilities Manual § 6-1310.4H.

### **6-1311 Reforestation**

6-1311.1 Reforestation is the establishment of a forest ecosystem on open ungraded areas. Forest ecosystems reduce the peak rate and volume of stormwater runoff through interception of rainfall by leaves and the forest duff layer, plant uptake and evapotranspiration, and infiltration into the soil. Forest ecosystems improve water quality by capturing and filtering airborne depositional pollutants, plant uptake of dissolved pollutants, and infiltration into the soil. Tree canopies provide energy conservation for buildings, screening, and other benefits in addition to stormwater management. Reforested areas may be used to meet the tree cover requirements of §12-0000 *et seq.* and Article 13 of the Zoning Ordinance. Tree cover credit equivalent to the square footage of the area will be given for reforested areas that have been planted, and are established in accordance with the provisions of this section.

#### **6-1311.2 General Requirements.**

6-1311.2A Reforested areas shall be placed in restrictive easements that include limited provisions for management practices necessary to assure the establishment of a healthy forest ecosystem. In residential areas, reforested areas must be located on Home Owner Association (or "common") property and may not be located on individual buildable single family detached or attached residential lots, or any part thereof for the purpose of satisfying the detention or water quality control (BMP) requirements of the Subdivision or Zoning Ordinance. Reforested areas may not be located on individual residential lots in nonbonded subdivisions to satisfy the BMP requirements of the Chesapeake Bay Preservation Ordinance.

6-1311.2B Reforested areas shall be privately managed and maintained.

6-1311.2C Post-development hydrology. A runoff coefficient "C" for reforested areas found in Table 6.6 shall be used for hydrologic computations using the Rational Method. The Curve Number "CN" for use with Natural Resources Conservation Service (NRCS) methods shall be based upon woods in good condition and the underlying Hydrologic Soil Group.

6-1311.2D Reforested areas shall be posted with permanent signs designating the area as a Conservation Area. Signs shall state that the area has been reforested as a Low Impact Development practice and no disturbance or cutting of vegetation is allowed. Signs must be a minimum of 8 inches (205 mm) by 10 inches (254 mm) mounted on posts at a height of four (4) feet (1.22 m) to six (6) feet (1.83 m) and placed at approximately 150 foot (46 m) intervals along the perimeter of the reforested area. See Plates 81-6 and 81M-6.

6-1311.2E In order to maximize the infiltration capacity, structure, and biota of the existing soil profile below the amended soil layer, areas to be reforested shall not be graded as part of the site development. The only land disturbance allowed is that which is necessary to amend the soils and install plantings.

#### **6-1311.3 Design of Reforested Areas.**

6-1311.3A Reforestation plans and specifications shall be prepared by a certified landscape architect, horticulturist, or other individual who is knowledgeable about the environmental tolerance, ecological functions, and impacts of plant species.

6-1311.3B Except as noted below, reforested areas shall have a minimum contiguous area of 6,000 square feet (557 m<sup>2</sup>), be generally regular in shape, and have a minimum width of 35 feet (10.7



m). The Director may approve areas less than 6,000 square feet (557 m<sup>2</sup>) in size or with minimum widths less than 35 feet (10.7 m) provided such areas are contiguous to existing naturally vegetated areas that are preserved with restrictive easements or other long-term protective mechanisms or that are in uses associated with long-term preservation.

6-1311.3C Reforested areas shall be designed to replicate adjacent forest communities using similar percentages of major indicator species or species that can adapt to abiotic conditions present in the area to be reforested. If there is no adjacent forest community to mimic, the area may be planted with pioneer species, such as Virginia pine, black locust, eastern redcedar, red maple, and persimmon.

6-1311.3D Reforested areas shall consist of a mixture of overstory trees, understory trees, and shrubs. Generally, overstory trees correspond to Category 3 or 4 trees and understory trees correspond to Category 1 or 2 trees as listed in Table 12.7 in §12-0000 *et seq.* At least 25% of the area shall be planted with trees from nursery stock. For nursery stock, deciduous trees must be a minimum of 1" (2.54 cm) caliper and evergreen trees must be a minimum of 6 feet (1.8 m) in height. For areas planted with nursery stock, the density of overstory trees shall be a minimum of 100 trees per acre and the density of understory trees shall be a minimum of 200 trees per acre. Nursery stock may be replaced by transplanted material as approved by the Director. For areas planted with bareroot seedlings (See § 12-0805.5A), the density of the trees shall be double that required for nursery stock. The density of shrubs shall be a minimum of 1089 plants per acre. Shrubs must be a minimum of 18 inches (0.4 m) in height.

6-1311.3E To curtail the spread of disease or insect infestation in a plant species, no more than 70% of the trees, seedlings, and shrubs required to be planted shall be of one genus. In addition, no more than

35% of the deciduous trees shall be of a single species and no more than 35% of the evergreen trees shall be of a single species. Seedlings shall be randomly mixed and placed approximately 8 - 10 feet (2.4 - 3.1 m) apart in a random pattern with shrubs placed surrounding seedlings. Additional guidance on appropriate species for soils and groundwater conditions can be found in § 12-0000.

6-1311.3F Tree planting credit may be given for existing trees within the planting area. A planting credit of one (1) 1 inch (2.54 cm) caliper nursery stock overstory tree shall be given for each 150 square feet (14 m<sup>2</sup>) of existing overstory tree canopy and a planting credit of one (1) 1 inch (2.54 cm) caliper nursery stock understory tree shall be given for each 75 square feet (7 m<sup>2</sup>) of existing understory tree canopy.

6-1311.3G Compacted soils will limit root growth and establishment of the forest ecosystem. Subsoiling (tilling) and soil amendments are required to relieve soil compaction and restore soil function in previously disturbed soils except as noted below.

6-1311.3G(1) Subsoiling and soil amendments are not required if the *in situ* bulk density of the existing soil, as measured by the sand cone test (ASTM D1556), is less than the value in Table 6.43 for the corresponding soil type or compaction, as measured by the cone penetration test (ASTM D3441), is less than 300 lb/in<sup>2</sup> (2068 kPa) in the top 15 inches (38 cm) of soil. A minimum of one density measurement or test shall be performed per 1,000 ft<sup>2</sup> (93 m<sup>2</sup>).

6-1311.3G(2) Testing of *in situ* soils to determine compaction is not required if soils will be amended at pre-approved rates in accordance with § 6-1311.5.

Table 6.43  
Bulk Densities That May Effect Root  
Growth<sup>1</sup>

Soil Texture	(lb/ft <sup>3</sup> )	(gm/cm <sup>3</sup> )
Sands, loamy sands	105.50	1.69
Sandy loams, loams	101.76	1.63
Sandy clay loams, loams, clay loams	99.88	1.60
Silts, silt loams	99.88	1.60
Silt loams, silty clay loams	96.76	1.55
Sandy clays, silty clays, some clay loams (35-45% clay)	93.02	1.49
Clays (>45% clay)	86.77	1.39

6-1311.4 Subsoiling and Soil Amendment Specifications.

6-1311.4A The topsoil layer shall have a minimum depth of 8 inches (20 cm) except for areas within the dripline of existing trees in or adjacent to the area to be reforested, where subsoiling may adversely impact tree roots. Compacted soils within the dripline of existing trees shall be addressed by the use of vertical mulching as specified in § 12-0806.4B. See Plates 1-12 & 13-12 (1M-12 & 13M-12).

6-1311.4B Subsoils below the amended topsoil layer shall be scarified to a depth of at least 4 inches (10 cm).

6-1311.4C A minimum of 2 inches (5 cm) of organic mulch shall be placed on the topsoil layer at final grade for stabilization purposes after planting. Mulch shall consist of wood chips, bark chips, or shredded bark, that has been aged for a minimum of 4 months. Alternatively, a native seed mixture combined with appropriate stabilization measures may be used.

<sup>1</sup> From *Protecting Urban Soil Quality: Examples for Landscape Codes and Specifications* USDA 2003

6-1311.5 Construction Specifications for Subsoiling with Soil Amendments. The following construction specifications are designed to achieve an 8 inch (20 cm) depth of topsoil and scarification of compacted subsoil 4 inches (10 cm) below the topsoil layer for a total uncompacted depth of 12 inches (30 cm).

6-1311.5A Scarify or till subgrade to 8 inches (20 cm) depth. The entire surface shall be scarified except for the area within the drip lines of existing trees to be retained.

6-1311.5B Place and rototill 3 inches (8 cm) of organic compost meeting the requirements of Table 6.32 into 5 inches (13 cm) of soil.

6-1311.5C Water thoroughly and allow soil to settle for one week.

6-1311.5D Rake beds to smooth and remove surface rocks larger than 2 inches (5 cm) in diameter.

6-1311.5E Planting should occur as soon as feasible after the soil has been amended.

6-1311.5F After planting, mulch planting beds with 2 inches (5 cm) of organic mulch. Mulch shall consist of wood chips, bark chips, or shredded bark, that has been aged for a minimum of 4 months. Alternatively, a native seed mixture combined with appropriate stabilization measures may be used. Installation of the above stabilization measures shall be in accordance with the Virginia Erosion and Sediment Control Handbook, 3<sup>rd</sup> edition, 1992.

6-1311.5G An inspection report shall be provided to DPWES for review prior to bond release. This report shall include observed survival rates of plantings, replacement plantings installed, material delivery tickets, and certifications from material suppliers. For projects requiring as-built plans, the required inspection report and supporting documents shall be

submitted with or incorporated in the as-built plans. For projects that do not require as-built plans, the required report and supporting documents shall be submitted with the RUP or non-RUP request.

#### 6-1311.6 Planting Requirements.

6-1311.6A Planting procedures for trees, shrubs and seedlings shall be in conformance with § 12-0805.

6-1311.6B Planting of the reforested area should be done with minimal mechanical disturbance to the existing trees and shrubs to be preserved and given credit per § 6-1311.3F. The planting should be done by hand or mechanical auger.

6-1311.6C Plantings must be well established prior to release of the conservation deposit. The conservation deposit will be held for a minimum of two years after the initial installation of the plantings. Ninety percent or more of the minimum number of nursery stock trees and shrubs required by the approved plan shall be viable (healthy and capable of developing a trunk and branch structure typical for their species) at the time the conservation deposit is released. Sixty-seven percent or more of the initial tree seedling density required by the approved plan shall be viable at the time the conservation deposit is released. If these minimum percentages are not met at the time of inspection, additional nursery stock trees, nursery stock shrubs, and seedlings shall be planted at densities necessary to achieve the required minimum percentages of viability of the

initial plantings based on the observed mortality rates. For example, if the plan called for 500 seedlings to be planted, a minimum of 335 seedlings (67%) must be viable more than 2 years after installation. If 250 seedlings were viable (a deficit of 85 viable plants) at the time of inspection (2.5 years after installation), 170 replacement seedlings would need to be planted, based on the observed mortality rate (50%), prior to release of the conservation deposit. Replacement seedlings shall be selected such that the resulting mixture of surviving and replacement plants will generally achieve the mixture of understory trees and overstory trees shown on the approved plan as determined by the Director.

#### 6-1311.7 Plan Submission Requirements.

6-1311.7A Plant schedule and planting plan specifying species, quantity of each species, stock size, type of root stock to be installed, and spacing of proposed plants within the reforested area.

6-1311.7B Reforested areas shall be delineated on the plan sheets with the note: "Reforestation Area. This area is being replanted for Low Impact Development credit. No disturbance other than that necessary to implement the planting plan allowed."

6-1311.7C Construction specifications for soil amendments (if provided) and planting procedures.

6-1311.7D *In situ* soil test results if performed (See § 6-1311.3G).

**Amend PFM 13-0000 (STRUCTURE. INTERPRETATIONS, DEFINITIONS, ABBREVIATIONS & UNIT CONVERSION TABLES) Section 13-0300 (Definitions and Abbreviations) to add the following:**

**13-0300 DEFINITIONS AND ABBREVIATIONS.** (53-96-PFM) The following definitions may be used in the interpretation and administration of the PFM. The definitions of various terms as presented herein do not necessarily represent the same definitions as may be found for the same terms in Chapters of the Code. Abbreviations in this section may appear in upper- or lower-case within the PFM. For the purpose of this publication, the following words and phrases shall have the meanings as respectively ascribed to them:

.  
. .  
.

MSA - Methods of Soil Analysis, Part I Physical and Mineralogical Methods, American Society of Agronomy (1986)

.  
. .  
.

# FAIRFAX COUNTY PUBLIC FACILITIES MANUAL

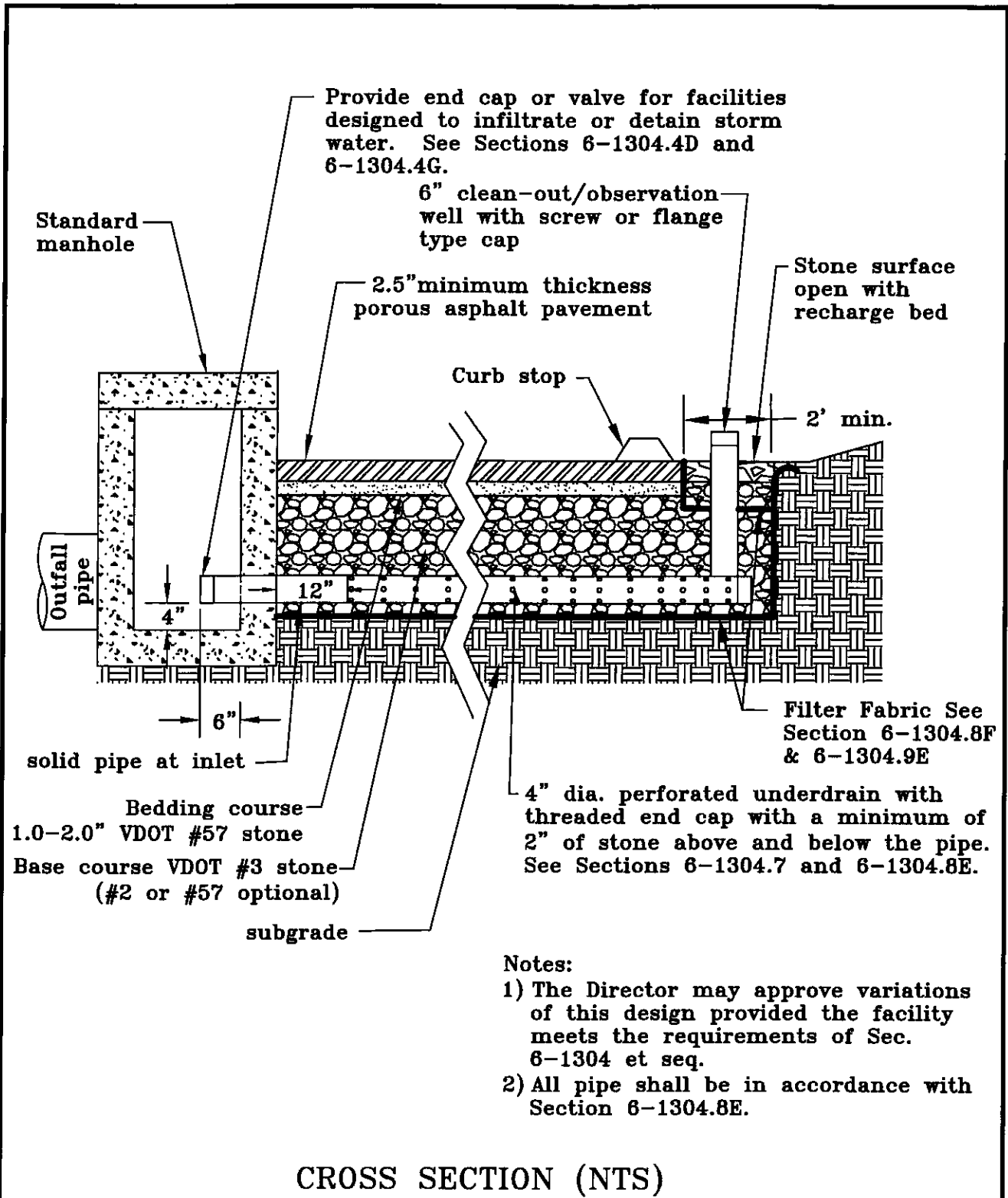

Ref. Sec. 6-1304 et seq.  Rev. 3-07	<b>POROUS ASPHALT PAVEMENT EXTENDED AGGREGATE BASE</b>	PLATE NO.  <b>78-6</b>	STD. NO.
---	--	------------------------------	----------

# FAIRFAX COUNTY PUBLIC FACILITIES MANUAL

**Notes:**

- 1) The Director may approve variations of this design provided the facility meets the requirements of Sec. 6-1304 et seq.
- 2) All pipe shall be in accordance with 6-1304.8E.
- 3) Provide end cap or valve for facilities designed to infiltrate or detain storm water. See Sections 6-1304.4D and 6-1304.4G.

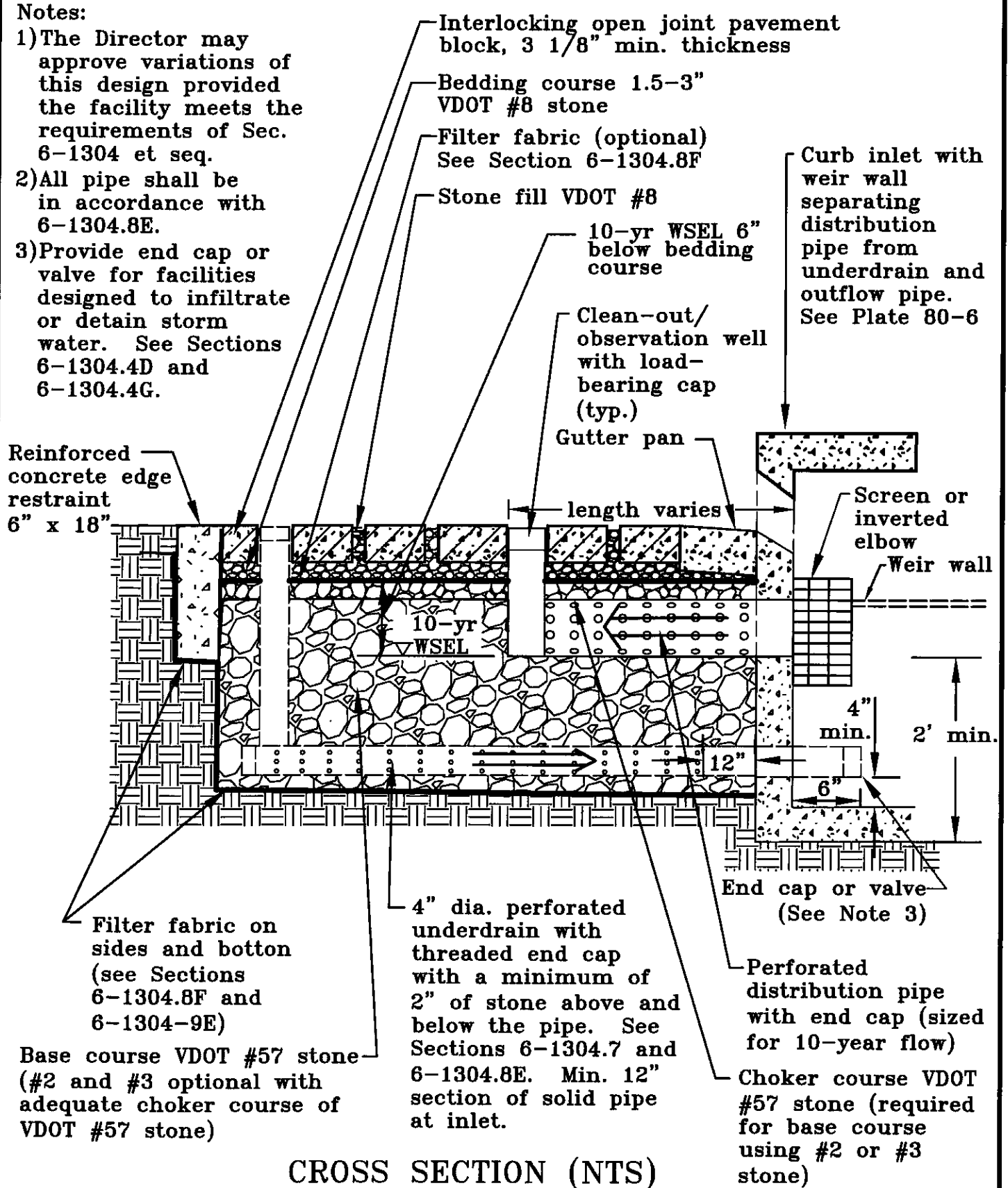

Ref. Sec. 6-1304 et seq.

## PERMEABLE OPEN JOINT PAVEMENT BLOCK

PLATE NO.    STD. NO.

79-6

Rev. 3-07

# FAIRFAX COUNTY PUBLIC FACILITIES MANUAL

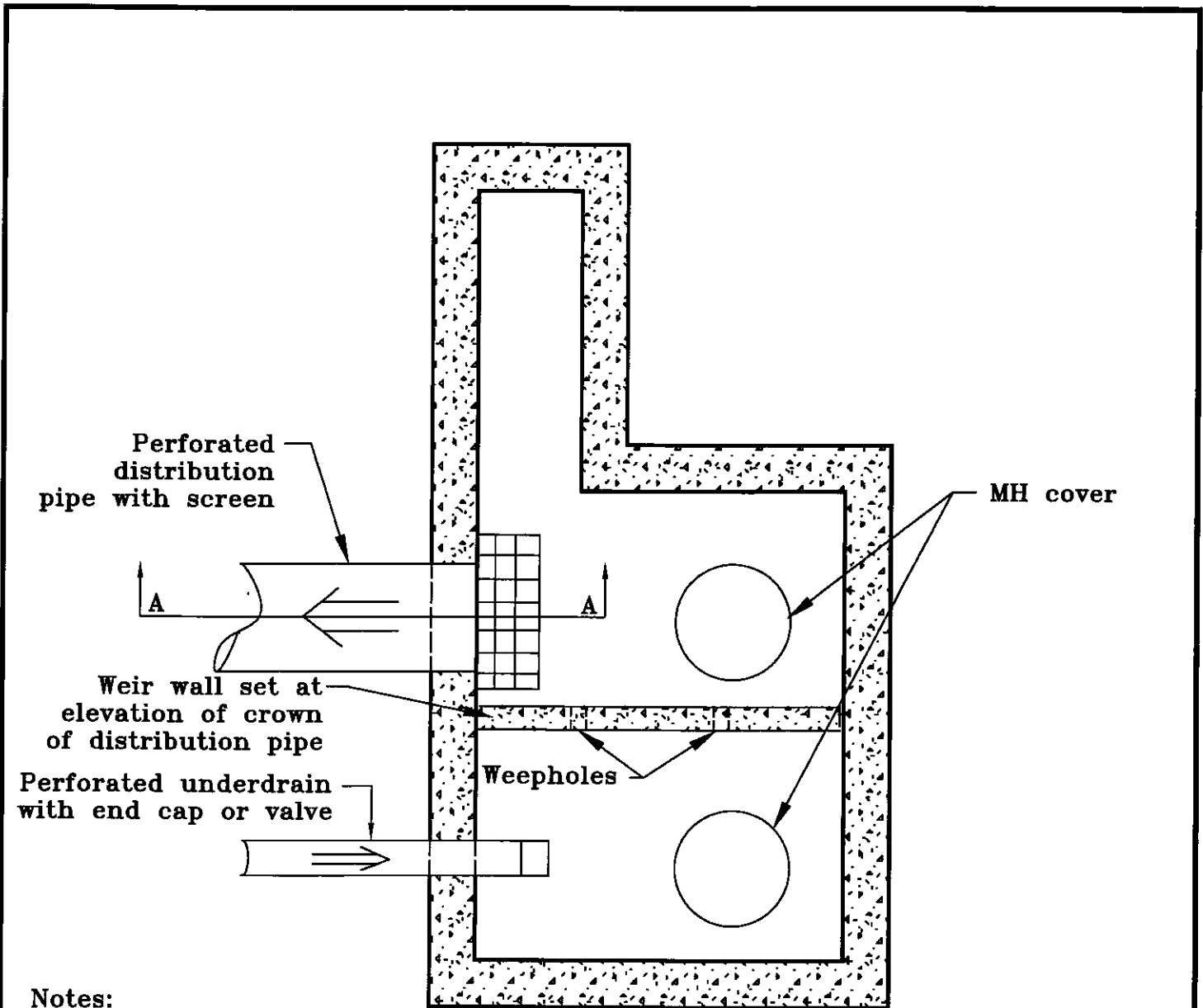

**Notes:**

- 1) For cross-section A-A see Plate 79-6.
- 2) Distribution pipe sized to convey stormwater in excess of the water quality to the aggregate base or storage chambers below the pervious pavement.
- 3) This is intended as an example only. The designer may use other configurations, including separate inflow and outflow structures which may include manufactured water quality inlets.

**PLAN VIEW (NTS)**

Ref. Sec. 6-1304 et seq.	<b>EXAMPLE INLET SCHEMATIC FOR PERVIOUS PAVEMENT</b>	PLATE NO.	STD. NO.
Rev. 3-07		<b>80-6</b>	

# FAIRFAX COUNTY PUBLIC FACILITIES MANUAL

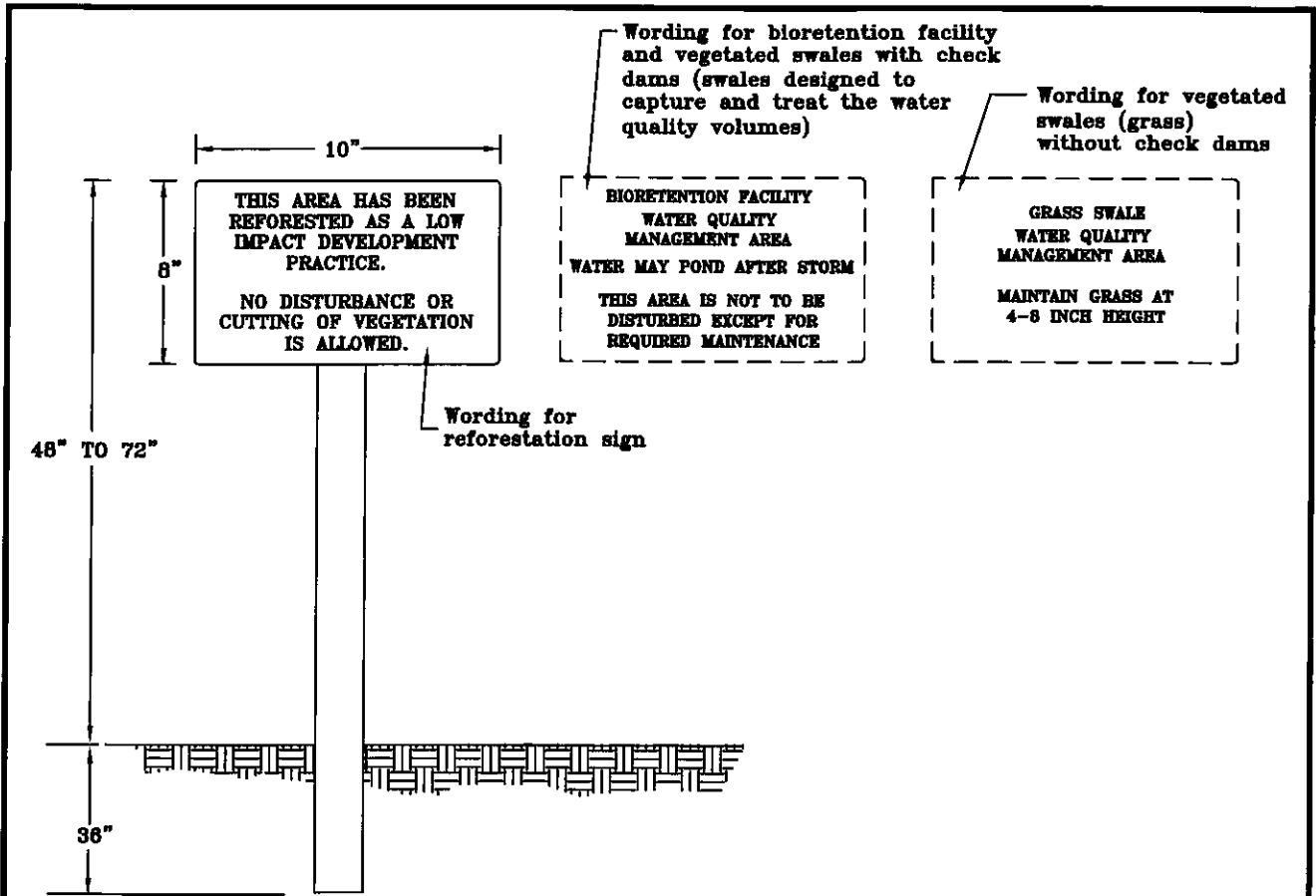

## GENERAL REQUIREMENTS

- 1) The sign is to be placed on a 3" "U" channel post 8' long.
- 2) The sign is to be placed at approximately 100-foot intervals along the perimeter of the reforested area or the bioretention facility. The sign is to be placed at approximately 100-foot intervals along the length of vegetated swales on alternating sides. Each reforested area, bioretention facility, and vegetated swale shall have a minimum of one sign.
- 3) The sign shall be made with reflective materials and be green with white border and standard 1/2" lettering.
- 4) Alternate design may be approved by the Director.
- 5) Sign is not to be placed in existing or proposed VDOT right-of-way.
- 6) Signs for bioretention facilities on individual single family lots may be placed on wood or metal posts at heights as low as 30" above ground and be made of non-reflective materials in colors other than green and white.

Ref. Sects. 6-1307.3C,  
6-1308.3C and  
6-1311.2D

REFORESTED AREA, BIORETENTION,  
OR VEGETATED SWALE SIGN

PLATE NO.

STD. NO.

81-6

Rev. 3-07



# FAIRFAX COUNTY PUBLIC FACILITIES MANUAL

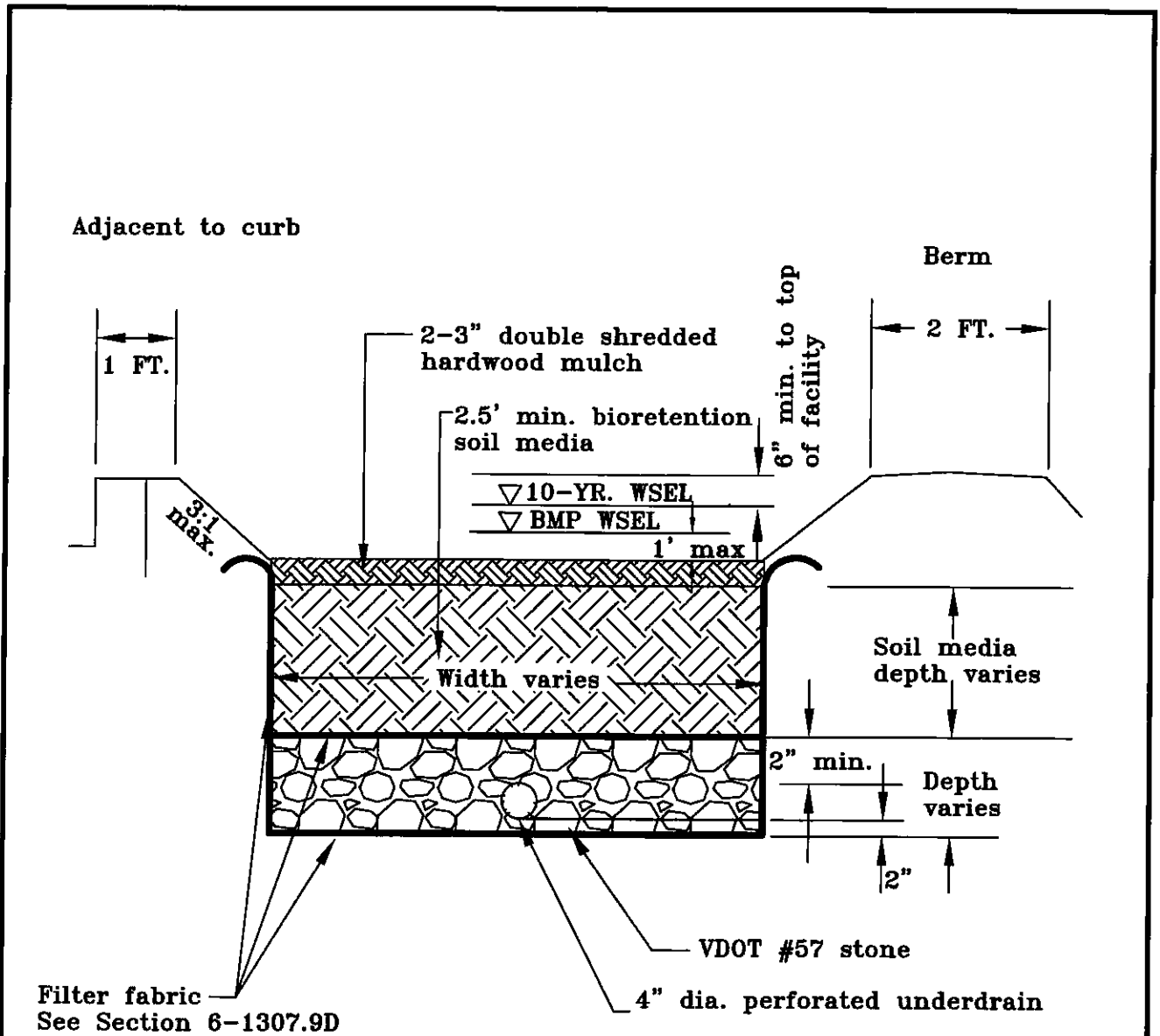

**Notes:**

- 1) Side slopes of the facility excavated below ground may be as steep as the in situ soils will permit. All excavation must be performed in accordance with VOSH requirements.
- 2) All pipe shall be in accordance with Section 6-1307.9C.

**Soil Media**

- 10-35% Topsoil
- 5-15% Organic Compost
- 60-75% Sand, ASTM C-33

**CROSS SECTION VIEW (NTS)**

Ref. Sec. 6-1307 et. seq.  Rev. 3-07	<b>BIORETENTION FILTER OR BASIN WITH STONE STORAGE</b>	PLATE NO.  <b>82-6</b>	STD. NO.
---	--	------------------------------	----------

# FAIRFAX COUNTY PUBLIC FACILITIES MANUAL

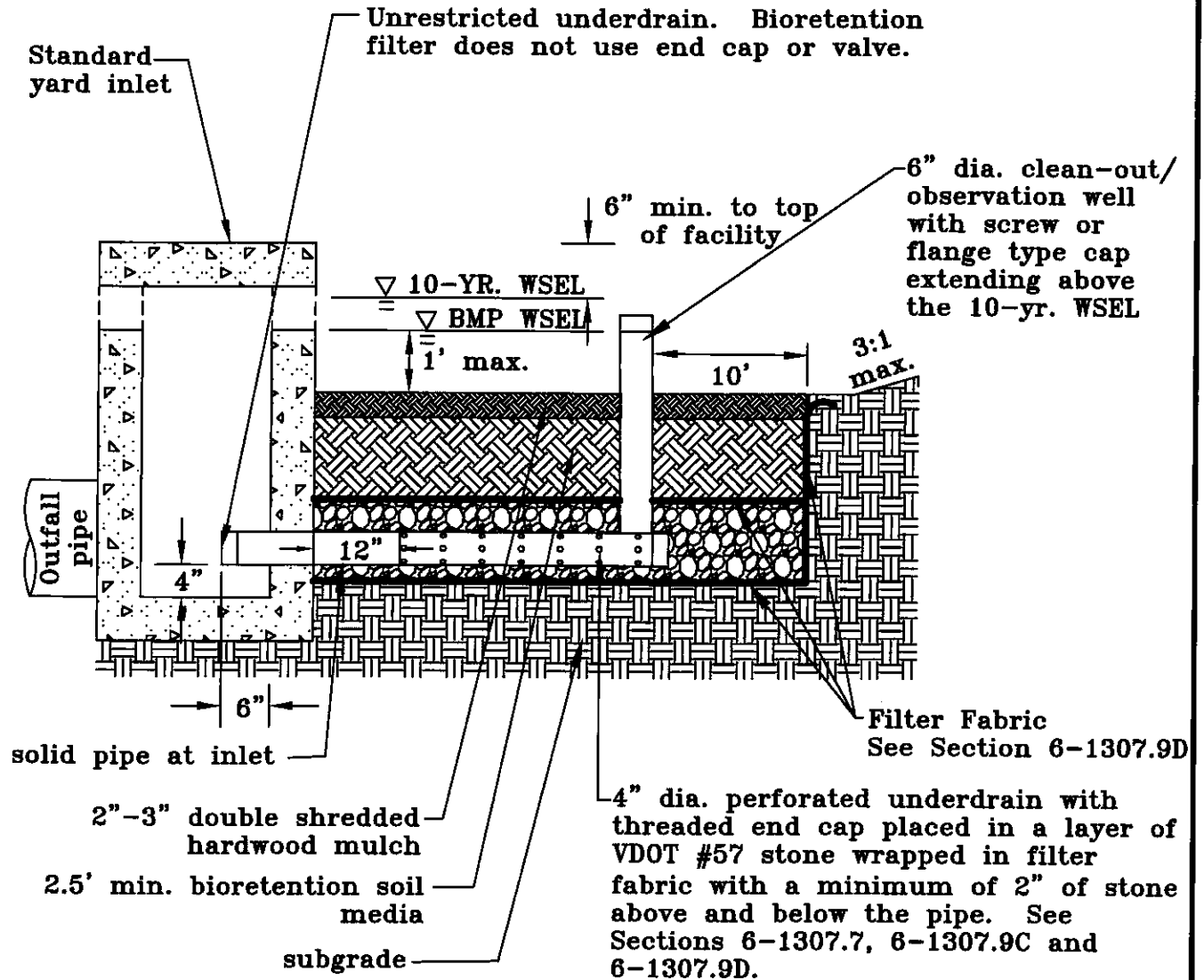

Filter Fabric  
See Section 6-1307.9D

4" dia. perforated underdrain with threaded end cap placed in a layer of VDOT #57 stone wrapped in filter fabric with a minimum of 2" of stone above and below the pipe. See Sections 6-1307.7, 6-1307.9C and 6-1307.9D.

2"-3" double shredded hardwood mulch

2.5' min. bioretention soil media

subgrade

6" dia. clean-out/observation well with screw or flange type cap extending above the 10-yr. WSEL

6" min. to top of facility

10-YR. WSEL

BMP WSEL

1' max.

10'

3:1 max.

12"

4"

6"

solid pipe at inlet

Outfall pipe

Standard yard inlet

Unrestricted underdrain. Bioretention filter does not use end cap or valve.

**Notes:**

- 1) The Director may approve variations of this design provided the facility meets the requirements of Sec. 6-1307 et seq.
- 2) All pipe shall be in accordance with Section 6-1307.9C.

**Soil Media**

10-35%	Topsoil
5-15%	Organic Compost
60-75%	Sand, ASTM C-33

## PROFILE VIEW (NTS)

Ref. Sect. 1307 et seq.	<b>BIORETENTION FILTER</b>	PLATE NO.	STD. NO.
Rev. 3-07		<b>83-6</b>	

# FAIRFAX COUNTY PUBLIC FACILITIES MANUAL

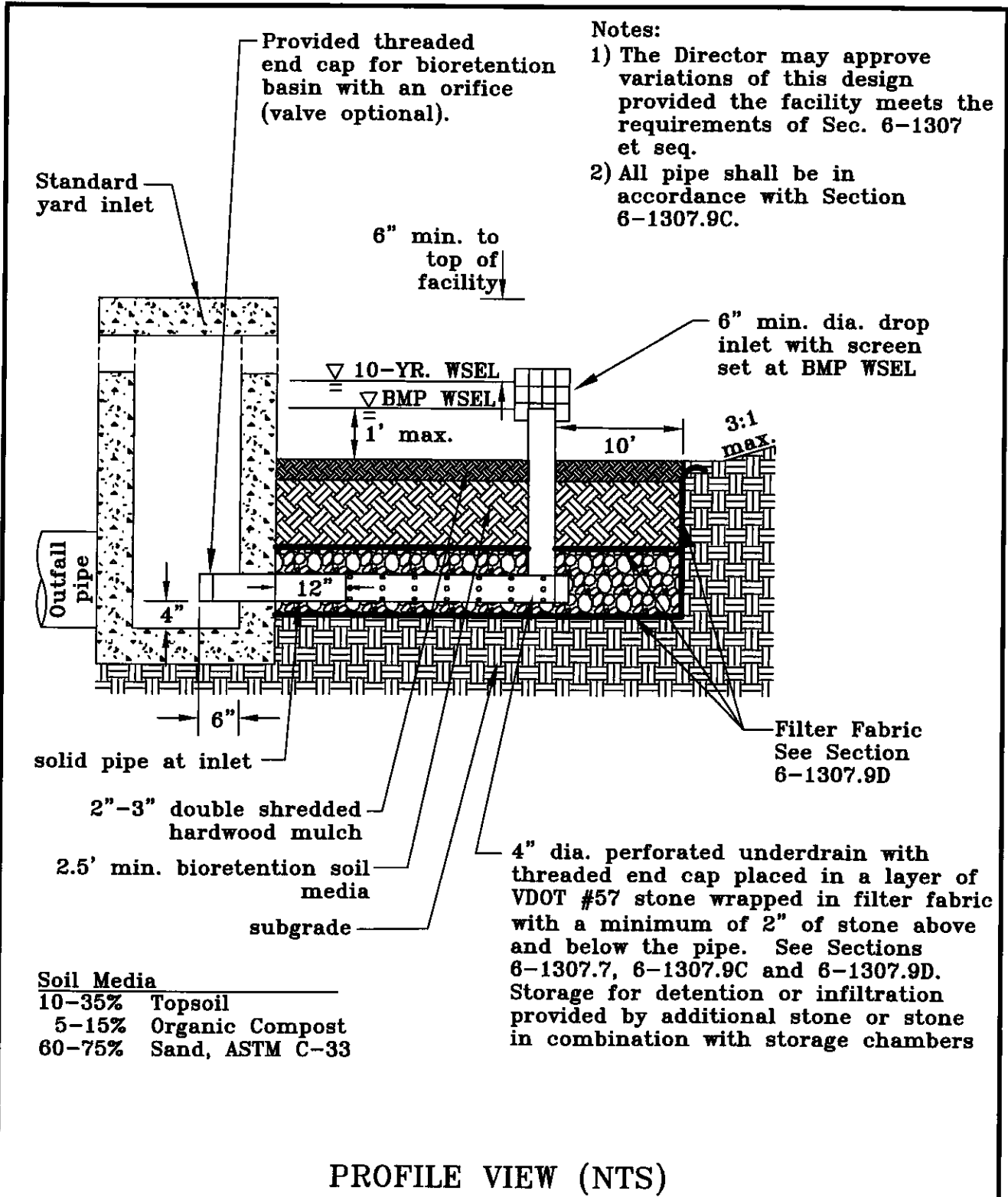

Ref. Sec. 6-1307 et seq.	<b>BIORETENTION BASIN</b>	PLATE NO.	STD. NO.
Rev. 3-07		<b>84-6</b>	

# FAIRFAX COUNTY PUBLIC FACILITIES MANUAL

**Note:**

- 1) The Director may approve variations of this design provided the facility meets the requirements of Sec. 6-1307 et seq.
- 2) All pipe shall be in accordance with Section 6-1307.9C.

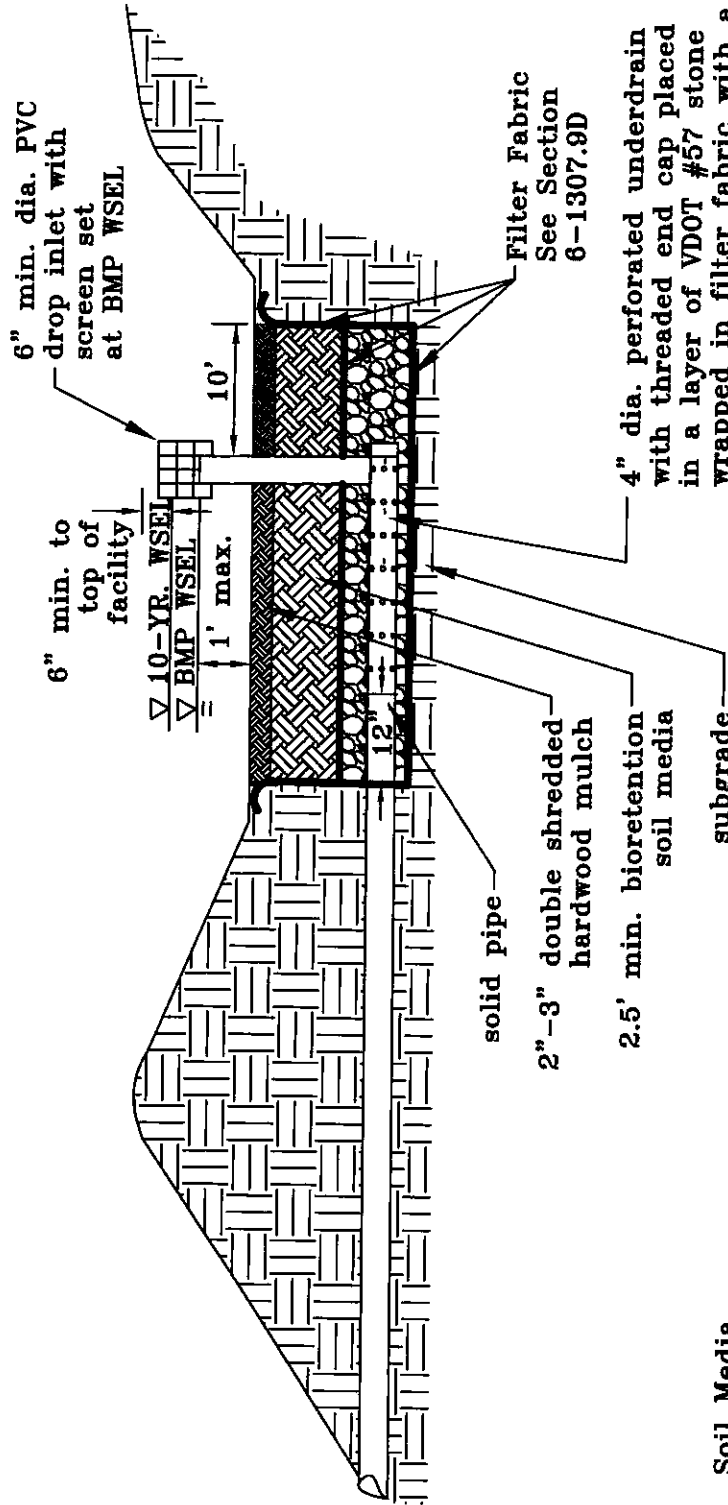

**Soil Media**  
 10-35% Topsoil  
 5-15% Organic Compost  
 60-75% Sand, ASTM C-33

4" dia. perforated underdrain with threaded end cap placed in a layer of VDOT #57 stone wrapped in filter fabric with a minimum of 2" of stone above and below the pipe. See Sections 6-1307.7, 6-1307.9C and 6-1307.9D. Storage for detention or infiltration provided by additional stone or stone in combination with storage chambers.

**PROFILE VIEW (NTS)**

Ref. Sec. 6-1307 et seq.

Rev. 3-07

## BIORETENTION FILTER OR BASIN (OUTFALL DAYLIGHTED)

PLATE NO.

STD. NO.

85-6

# FAIRFAX COUNTY PUBLIC FACILITIES MANUAL

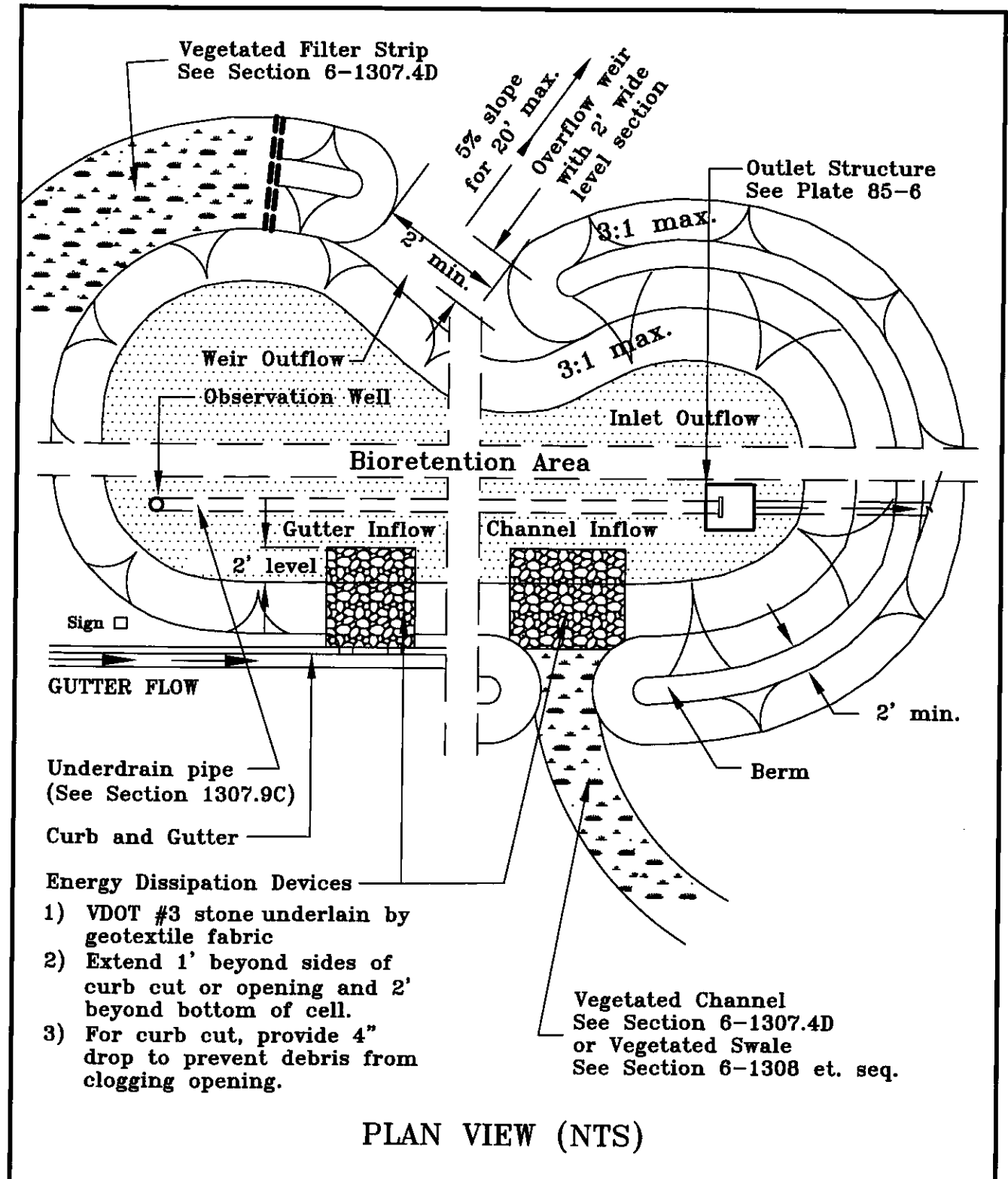

- Energy Dissipation Devices**
- 1) VDOT #3 stone underlain by geotextile fabric
  - 2) Extend 1' beyond sides of curb cut or opening and 2' beyond bottom of cell.
  - 3) For curb cut, provide 4" drop to prevent debris from clogging opening.

Ref. Sec. 6-1307 et seq.	<b>BIORETENTION FILTER &amp; BASIN</b>	PLATE NO.	STD. NO.
Rev. 3-07		<b>86-6</b>	

# FAIRFAX COUNTY PUBLIC FACILITIES MANUAL

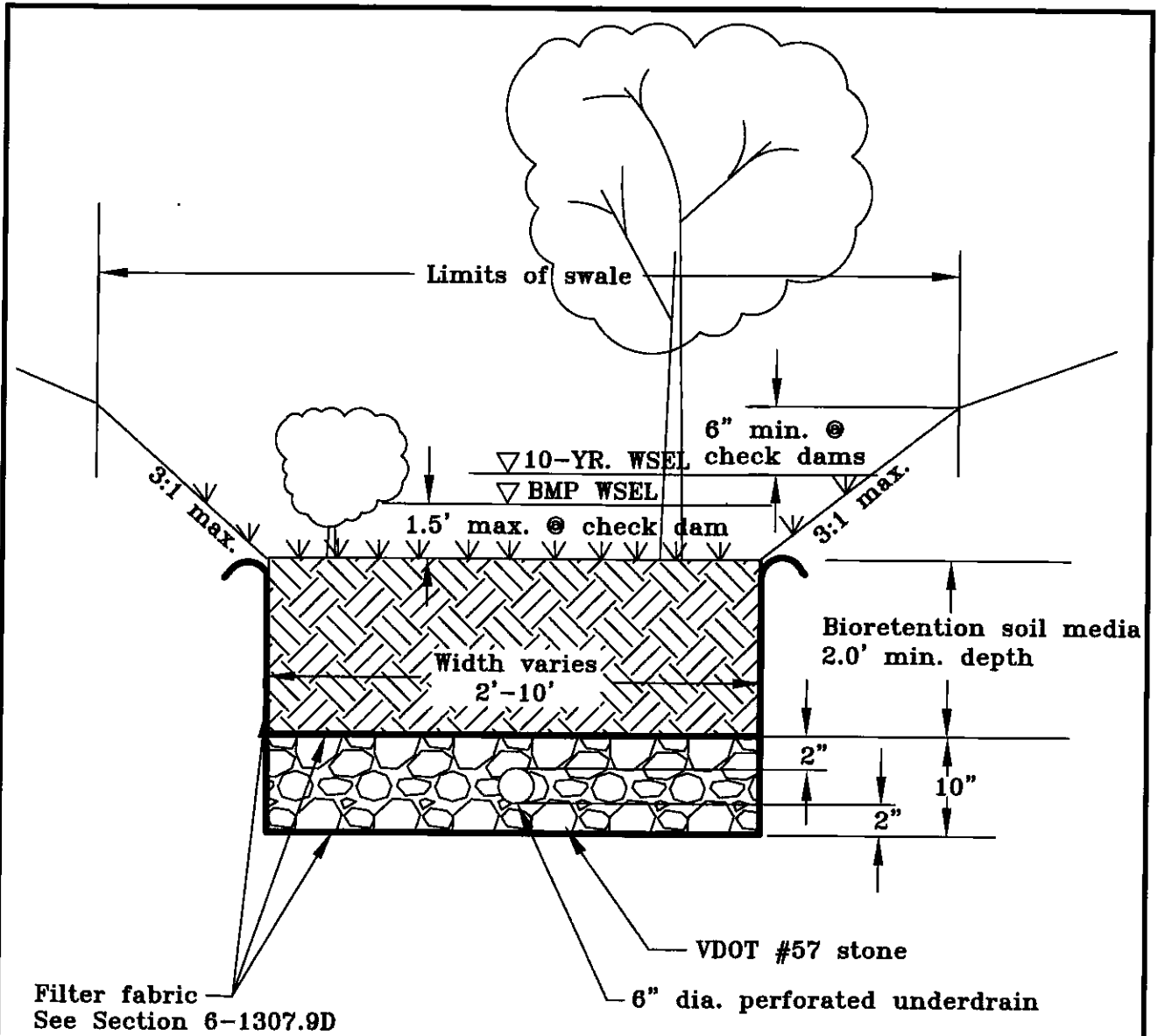

Filter fabric  
See Section 6-1307.9D

**Soil Media**  
 10-35% Topsoil  
 5-15% Organic compost  
 60-75% Sand, ASTM C-33

- Notes:**
- 1) Side slopes of the facility excavated below ground may be as steep as the in situ soils will permit. All excavation must be performed in accordance with VOSH requirements.
  - 2) All pipe shall be in accordance with Section 6-1307.9C.

**CROSS SECTION VIEW (NTS)**

Ref. Sec. 6-1308 et seq.	<b>VEGETATED SWALE WITH CHECK DAMS</b>	PLATE NO.	STD. NO.
Rev. 3-07		<b>87-6</b>	

# FAIRFAX COUNTY PUBLIC FACILITIES MANUAL

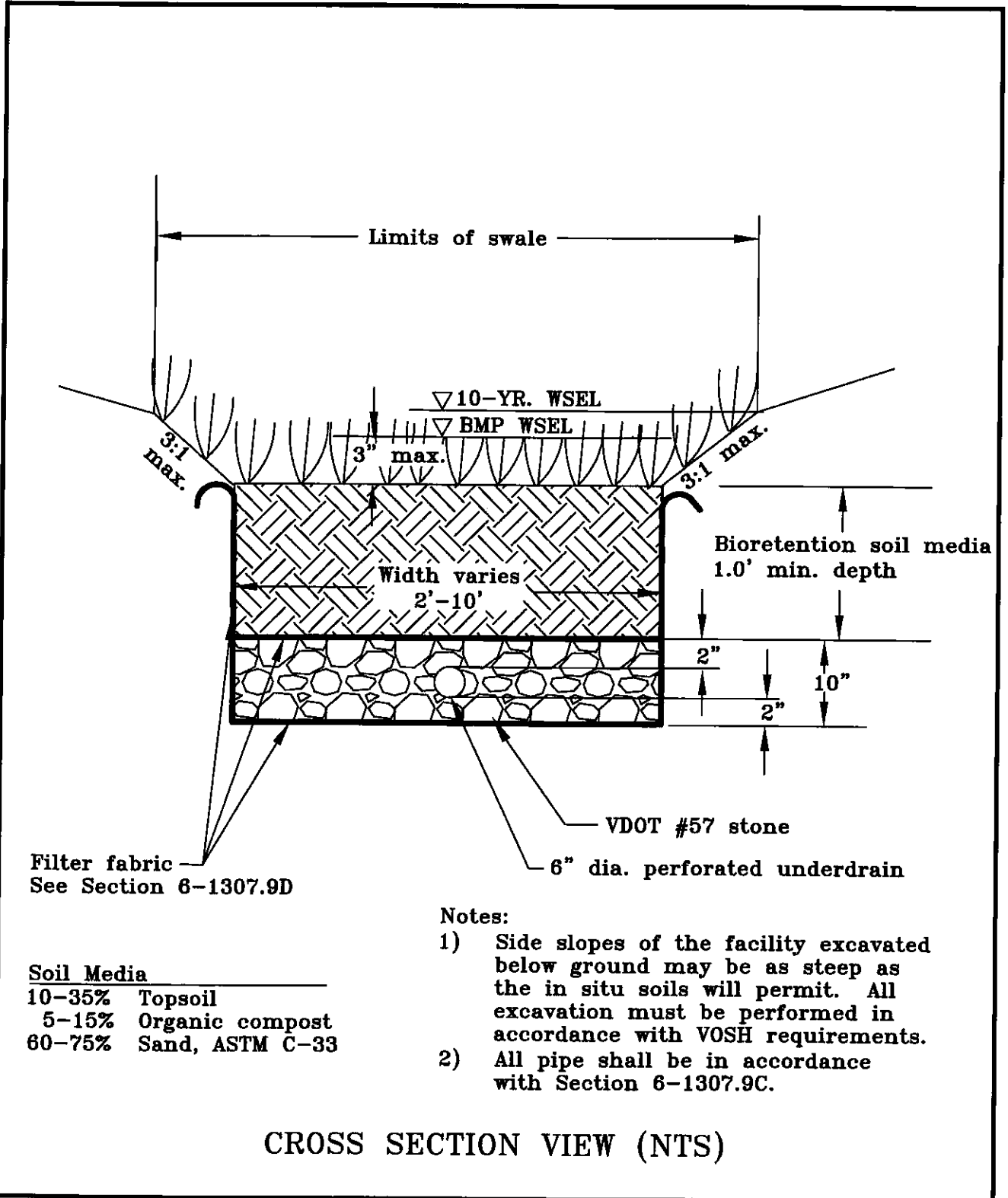

- Notes:**
- 1) Side slopes of the facility excavated below ground may be as steep as the in situ soils will permit. All excavation must be performed in accordance with VOSH requirements.
  - 2) All pipe shall be in accordance with Section 6-1307.9C.

**Soil Media**

- 10-35% Topsoil
- 5-15% Organic compost
- 60-75% Sand, ASTM C-33

**CROSS SECTION VIEW (NTS)**

Ref. Sec. 6-1308 et. seq.	<b>VEGETATED SWALE GRASS WITHOUT CHECK DAMS</b>	PLATE NO.	STD. NO.
Rev. 3-07		<b>88-6</b>	

# FAIRFAX COUNTY PUBLIC FACILITIES MANUAL

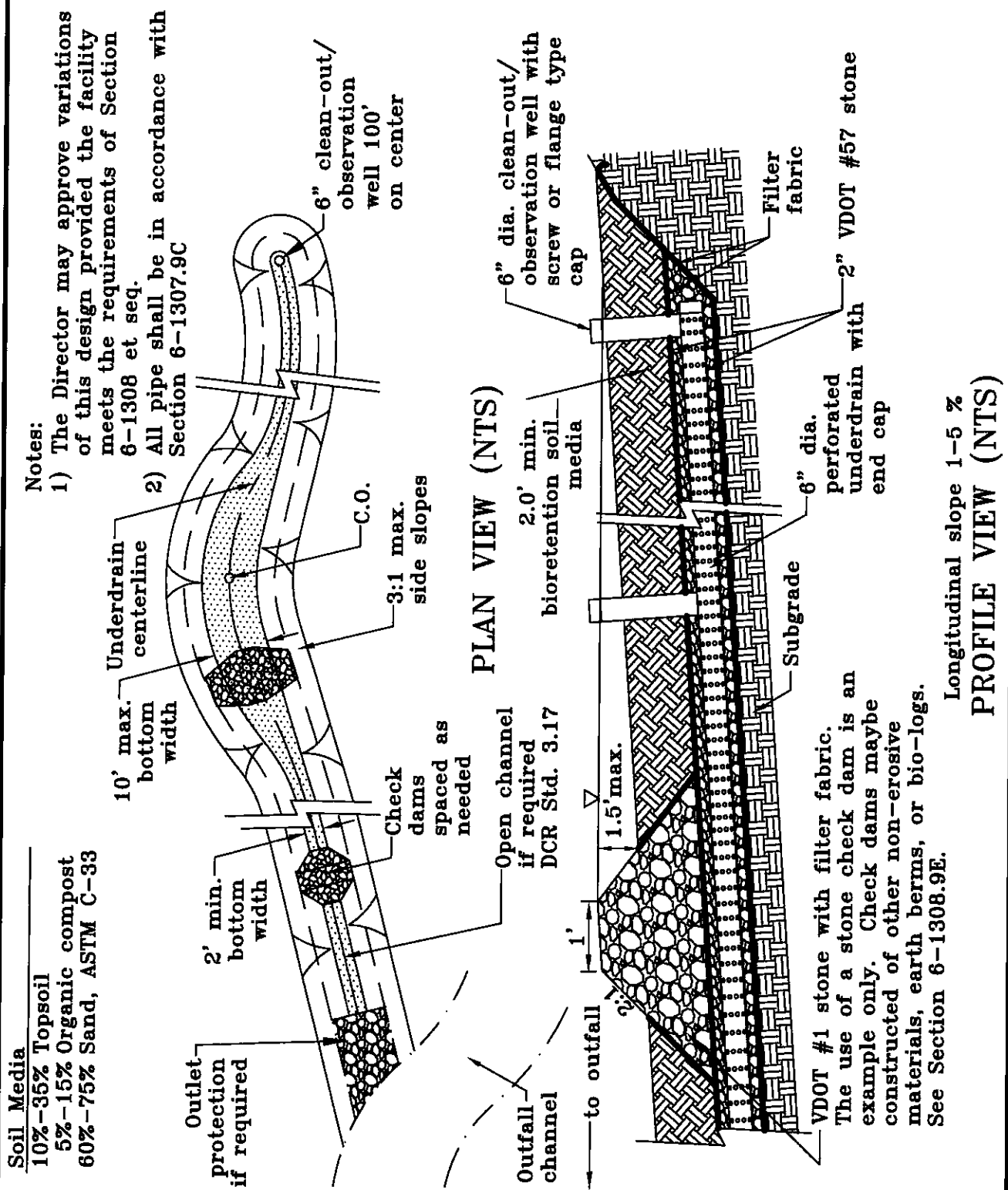

**Notes:**  
 1) The Director may approve variations of this design provided the facility meets the requirements of Section 6-1308 et seq.  
 2) All pipe shall be in accordance with Section 6-1307.9C

**Soil Media**  
 10% - 35% Topsoil  
 5% - 15% Organic compost  
 60% - 75% Sand, ASTM C-33

VDOT #1 stone with filter fabric. The use of a stone check dam is an example only. Check dams maybe constructed of other non-erosive materials, earth berms, or bio-logs. See Section 6-1308.9E.

Longitudinal slope 1-5 %  
**PROFILE VIEW (NTS)**

Ref. Sec. 6-1308 et seq.

## VEGETATED SWALE PLAN AND PROFILE

PLATE NO.

STD. NO.

Rev. 3-07

89-6



# FAIRFAX COUNTY PUBLIC FACILITIES MANUAL

**Note:**

- 1) The Director may approve variations of this design provided the facility meets the requirements of Sec. 6-1309 et seq.
- 2) All pipe shall be in accordance with Section 6-1307.9C.

4" dia. perf. underdrain pipe

Discharge to approved outfall  
4" dia. solid pipe

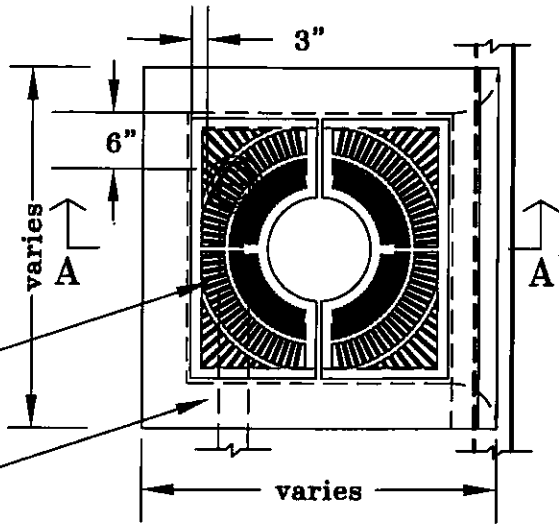

**PLAN VIEW**

Vegetation  
See Sec. 6-1309.8

Grate and frame  
H-20 loading

Cleanout 4" dia. pipe  
with screw or flange  
type cap

4" dia. perf. underdrain

VDOT #57 stone with a min. of 2" of stone above and below the pipe. See Secs. 6-1309.6 and 6-1309.7C.

Concrete box:  
pre-cast or cast-in-place  
See Section 6-1309.4F

Open bottom  
(optional)  
See Section  
6-1309.4G

2.5' bioretention soil media  
10-35% Topsoil  
5-15% Organic Compost  
60-75% Sand, ASTM C-33

VDOT #3 stone  
6" width and depth

2-3" double shredded  
hardwood mulch

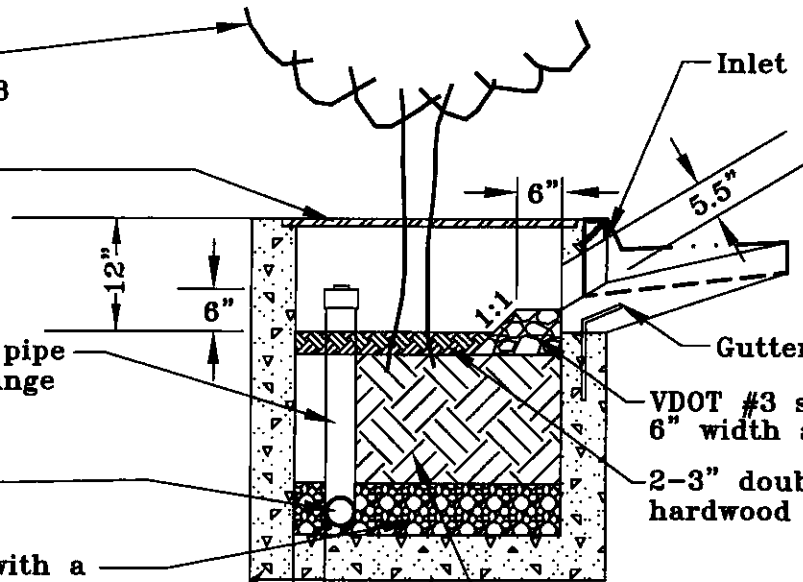

**CROSS SECTION A-A'**

Ref. Sec. 6-1309  
et seq.

Rev. 3-07

## TREE BOX FILTER

PLATE NO.

STD. NO.

90-6

# FAIRFAX COUNTY PUBLIC FACILITIES MANUAL

Note: The Director may approve variations of this design provided the facility meets the requirements of Sec. 6-1310 et seq.

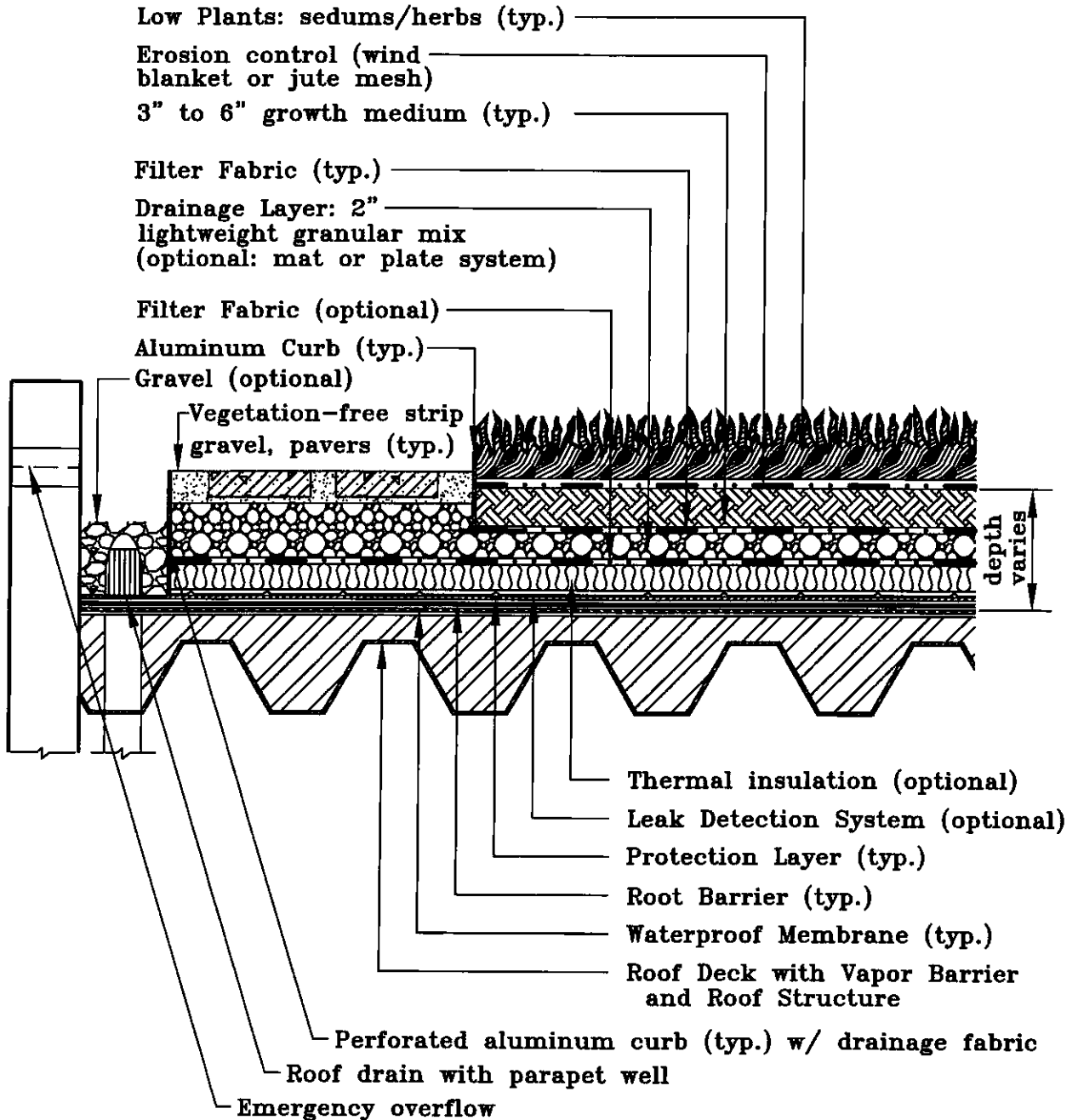

Ref. Sec. 6-1310 et seq.  Rev. 3-07	<b>VEGETATED ROOF EXTENSIVE</b>	PLATE NO.  91-6	STD. NO.
---	---------------------------------	-----------------------	----------

# FAIRFAX COUNTY PUBLIC FACILITIES MANUAL

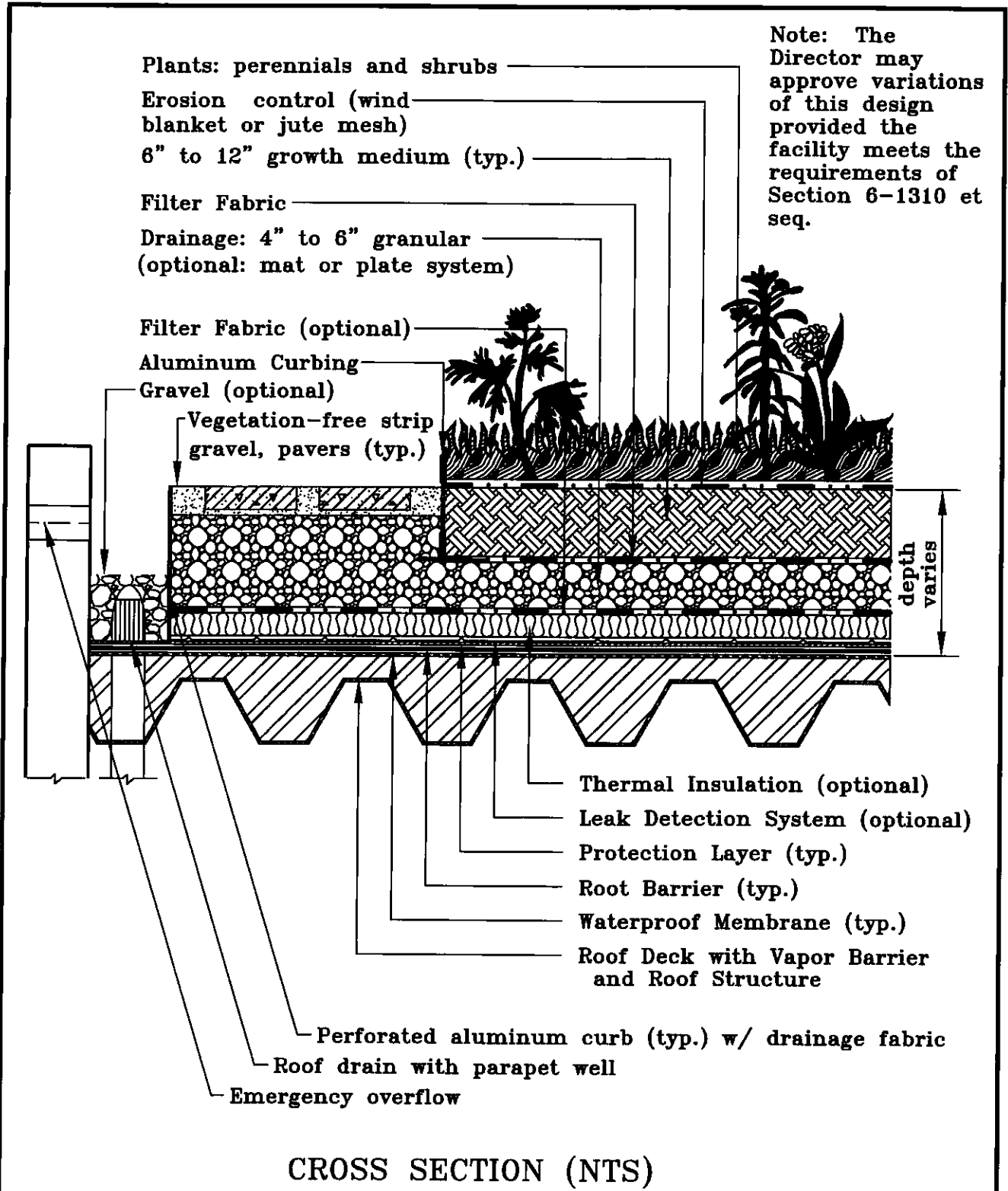

Ref. Sec. 6-1310 et seq.	<b>VEGETATED ROOF INTENSIVE</b>	PLATE NO.	STD. NO.
Rev. 3-07		92-6	